

clonoSEQ® Assay

Technical Information

Adaptive Biotechnologies Corporation
1165 Eastlake Ave E, Seattle, WA 98109
Phone: (206) 659-0067

Intended Use

The clonoSEQ Assay is an *in vitro* diagnostic that uses multiplex polymerase chain reaction (PCR) and next-generation sequencing (NGS) to identify and quantify rearranged IgH (VDJ), IgH (DJ), IgK and IgL receptor gene sequences, as well as translocated BCL1/IgH (J) and BCL2/IgH (J) sequences in DNA extracted from bone marrow from patients with B-cell acute lymphoblastic leukemia (ALL) or multiple myeloma (MM), and blood or bone marrow from patients with chronic lymphocytic leukemia (CLL).

The clonoSEQ Assay measures minimal residual disease (MRD) to monitor changes in burden of disease during and after treatment. The test is indicated for use by qualified healthcare professionals in accordance with professional guidelines for clinical decision-making and in conjunction with other clinicopathological features.

The clonoSEQ Assay is a single-site assay performed at Adaptive Biotechnologies Corporation in Seattle, Washington.

Contraindications

There are no known contraindications.

Special Conditions for Use

- For *in vitro* diagnostic use.
- For prescription use only (Rx only).

Summary and Explanation

The clonoSEQ Assay utilizes NGS to interrogate the frequency and distribution of DNA sequences/rearrangements that characterize a “dominant” clonotype consistent with a malignant lymphocyte population in a high tumor burden sample. In subsequent samples during and after treatment, these DNA sequences are analyzed and quantified to determine the MRD level. MRD refers to the measurable number of cancer cells that remain in a person during and following treatment. Clinical practice guidelines in select hematological malignancies recognize that MRD status is a reliable indicator of clinical outcome and response to therapy. Studies in select hematological malignancies have demonstrated the strong correlation between MRD and risks for relapse, as well as the prognostic significance of MRD measurements during and after therapy.¹⁻⁶

In acute lymphoblastic leukemia, MRD assessment has been established as an essential component in clinical management and is recommended upon completion of initial induction and at additional time points based on the regimen used.⁷

In multiple myeloma, MRD assessment after each treatment stage is recommended (e.g., after induction, high-dose therapy/ASCT, consolidation, maintenance). MRD tests may also be initiated at the time of suspected complete response.⁸

In chronic lymphocytic leukemia, clinical practice guidelines recommend the complete eradication of disease as a treatment goal in fit patients and include MRD assessment in blood or bone marrow using a technology with high sensitivity.^{9, 10,11}

Limitations

ALL, MM, and CLL

- MRD values obtained with different assay methods may not be interchangeable due to differences in assay methods and reagent specificity.
- The results obtained from this assay should always be used in combination with the clinical examination, patient medical history, and other findings.
- The clonoSEQ Assay is for use with specimens collected in EDTA tubes.
- Results may vary according to sample time within the course of disease or by sampling site location.
- The assay may overestimate MRD frequencies near the limit of detection (LoD).
- The MRD frequency LoD varies based on the amount of gDNA that is tested and using lower gDNA input may prevent MRD detection at low frequencies.
- Sample processing and cell enrichment strategies may affect the measured MRD frequency.
- The volume and cellularity of sampled input material may affect the ability to detect low levels of disease.
- False positive or false negative results may occur for reasons including, but not limited to: contamination; technical and/or biological factors such as the type of rearrangement or the size of the junction region.
- The assay has been validated with the Illumina NextSeq 500 and 550.

For CLL

- MRD is based on measurements of tumor cells detected in peripheral blood and/or bone marrow. However, patients may have significant residual disease in unassessed compartments and U-MRD in one compartment cannot fully rule out the presence of disease in the other compartment, for example, U-MRD in blood may not be the same in bone marrow. Therefore assessment of MRD in CLL should employ a multimodal approach including clinical examination, patient medical history, and other findings.
- Outcome for patients with MRD detectable in bone marrow but not in peripheral blood (PB-/BM+) may differ according to type of therapy.

- This assay is capable of monitoring specific tumor clonotypes. The association between MRD assessments and patient clinical status for the purpose of monitoring changes in disease (e.g., relapse, remission, stable disease) has not been demonstrated.
- The value of MRD in CLL for previously untreated or “watch and wait” patients is not established.
- CLL is a heterogeneous disease. MRD values and expectations for outcome may not be generalizable across treatments. Changes in MRD should be interpreted with caution when used to evaluate disease burden in therapies that have not been validated.
- Regardless of MRD status, cytogenetics play an independent role in patient risk status and its impact on PFS/OS.

Test Principle

The clonoSEQ Assay is a next-generation sequencing (NGS) based assay that identifies rearranged IgH (VDJ), IgH (DJ), IgK, and IgL receptor gene sequences, as well as translocated BCL1/IgH (J) and BCL2/IgH (J) sequences. The assay also includes primers that amplify specific genomic regions present as diploid copies in normal genomic DNA (gDNA) to allow determination of total nucleated cell content.

Testing begins with gDNA extracted from the specimen supplied (**Figure 1**). Extracted gDNA quality is assessed and rearranged immune receptors are amplified using a multiplex PCR. Reaction-specific index barcode sequences for sample identification are added to the amplified receptor sequences by PCR. Sequencing libraries are prepared from barcoded amplified DNA, which are then sequenced by synthesis using NGS. Raw sequence data are uploaded from the sequencing instrument to the Adaptive analysis pipeline. These sequence data are analyzed in a multi-step process: first, a sample’s sequence data are identified using the sample index sequences. Next, data are processed using a proprietary algorithm with in-line controls to remove amplification bias. When the clonoSEQ Clonality (ID) assessment is conducted, the immune repertoire of the sample is checked for the presence of DNA sequences specific to “dominant” clone(s) consistent with the presence of a lymphoid malignancy. Each sequence that is being considered for MRD tracking is compared against a B cell repertoire database and assigned a uniqueness value that, together with its abundance relative to other sequences, is used to assign the sequence to a sensitivity bin which will be used in the estimation of the reported LoD and LoQ on the patient report. During clonoSEQ Tracking (MRD) assessment, the complete immunoglobulin receptor repertoire is again assessed, and the previously identified dominant clonotype sequence(s) are detected and quantified to determine the sample MRD level. The clonoSEQ Assay MRD assessment measures residual disease in a biologic sample.

Figure 1: clonoSEQ Assay Workflow

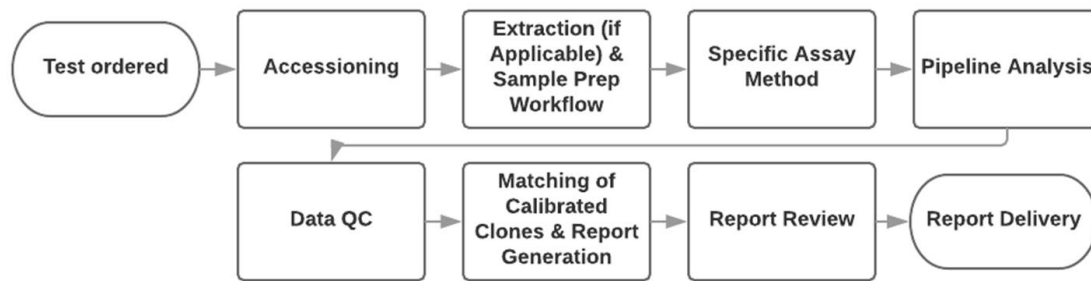

Following completion of these data processing steps, a report is issued. A Clonality (ID) report indicates the presence of dominant sequences residing within a presumed malignant lymphocyte clonal population, as identified in the baseline (diagnostic or high disease burden) sample from a patient. After one or more dominant sequence(s) have been identified in a baseline sample, subsequent samples from the same patient can be assessed for MRD after which a Tracking (MRD) report is generated. The MRD is expressed as a frequency that quantifies the level of residual disease based on the number of remaining copies of the initially dominant sequence(s) relative to the total number of nucleated cells in the sample.

Device Description

Sample Preparation

The minimum gDNA sample input requirement is 500 ng. Shipment of 1 mL of bone marrow aspirate (BMA) is requested to obtain sufficient extracted gDNA and extraction methods have been validated using volume ranging from 250 μ L to 1 mL. Shipment of 2 mL of whole blood is requested to obtain sufficient extracted gDNA and extraction methods have been validated using volumes ranging from 500 μ L to 2 mL. For both sample types, the extraction method isolates gDNA by first lysing cells and denaturing proteins after which the DNA is bound to a substrate. Once the DNA is bound, a series of wash steps removes impurities. Following the wash steps the DNA is eluted from the substrate. DNA is quantified using a spectrophotometer; the measured DNA concentration is used to add a target of 20 μ g of amplifiable gDNA to the assay. The MRD test can be performed with 500 ng – 20 μ g amplifiable gDNA. Internal controls in the PCR and sequencing steps are used to confirm that sufficient gDNA has been amplified and that amplification was successful.

Library Preparation

Genomic DNA is amplified using locus-specific multiplex PCR using V, D and J gene primers containing molecular barcodes to amplify IgH (VDJ), IgH (DJ), IgK, IgL, BCL1/IgH (J), BCL2/IgH (J) and housekeeping gene (HKG) sequences. Reaction-specific index barcodes for sample identification are added to the amplified receptor sequences by PCR. Sequencing libraries are prepared by pooling barcoded amplified DNA. qPCR is used to verify the adequacy of the pooled amplified DNA library concentration.

Sequencing and Data Analysis

Sequencing is conducted with the Illumina NextSeq™ 500 or 550 Systems. The sequencing process incorporates multiple quality checks. Sequencing output is then processed by the bioinformatics pipeline software as follows:

Flowcell Level Metrics

The analysis pipeline performs quality control (QC) checks on the flowcell data. The pipeline evaluates the percentage of reads that pass the Illumina quality filter (%PF), which must be greater than 70% of reads. The system uses spike-in PhiX templates to evaluate the error rate. The pipeline evaluates the proportion of PhiX reads, which must be greater than 2%, and the associated error rate as computed by the Illumina RTA software, which must be less than 3%.

Demultiplexing and FASTQ Generation

The pipeline uses Illumina software to demultiplex reads from the instrument output run folder. The analysis pipeline performs a QC check to evaluate whether unexpected barcodes are observed and raises a flag if more than 30,000 reads carry a barcode not specified in the input sample sheet.

Read Assignment to Receptors

The pipeline assigns reads to rearranged receptors for each sample after demultiplexing.

Clonal Sequence Determination

After assigning reads to receptor loci, the pipeline then clusters reads into clonal receptor sequences.

Sample Level QC Checks

The pipeline performs a series of sample level QC checks: assessment that sequencing data is sufficient and acceptable based on amplification of sets of internal synthetic controls, assessment that sufficient gDNA is sampled, and a final screen of the calculated values for biologic relevance. One set of internal synthetic controls are evaluated for sufficient read quantity per molecule and read coverage across receptor loci. Another set of internal controls' presence or absence is used to screen for the expected degradation of residual primers. The estimated mass of input gDNA based on an optical density measurement and the estimated number of sampled nucleated cells based on amplification of a set of internal reference genes are used as metrics to check if sufficient material is sampled. The pipeline also checks that the detected numbers of total and B cells are within a biologically relevant range, and screens for clone sharing by evaluating if sequences are shared across samples that are processed together.

Calibrations

Clonal sequences are assessed for their suitability as ID sequences (to be used for subsequent tracking) by first aggregating highly similar sequences and requiring that the frequency of the sequence is at least 3% as a percentage of all sequences in the locus. The clone must also have a frequency of at least 0.2% of all nucleated cells in the sample and must have sufficient abundance and differentiation from a polyclonal background. Each sequence that is being considered for MRD tracking is compared against a B cell repertoire database and assigned a

uniqueness value that, together with its abundance relative to other sequences, is used to assign the sequence to a sensitivity bin which will be used in the estimation of the reported LoD and LoQ.

Tracking

When a previous calibration test has identified suitable ID sequences for tracking, they are compared to sequences in the most recent tracking sample in order to assess residual disease. After approximate matching, which allows for mutations in the sample clones as compared to the ID sequences, sequence proportions in the sample are assessed and compared to the LoD and LoQ values. The analysis pipeline then reports whether ID sequences were detected above the LoQ, above LoD but below LoQ, below LoD, or not detected.

Control Materials

The following controls are used to measure the success of DNA extraction, PCR amplification and sequencing:

Synthetic Internal Controls

Each sample includes two sets of internal synthetic controls. The controls are panels of synthetic analogues of somatically rearranged B-cell receptor (BCR) immune receptor molecules. The composition of the reference template pools before and after amplification is measured and used for QC. One set of synthetic templates is added to every pre-amp PCR well as a positive control; these synthetic templates are used to measure primer performance, including identification and correction of amplification bias, and to screen for sufficient sequencing coverage. Another set is added after a step used to remove residual primers; the lack of amplification of these molecules is used to confirm the success of primer removal.

DNA Extraction Process Controls

Each extraction is performed with Positive and Negative Extraction Controls. The Extraction Negative Control is used to confirm lack of contamination during the extraction process. The Extraction Negative Control is subsequently amplified and sequenced in the same fashion as test samples. The Extraction Positive Control is included to assess effectiveness of the extraction process (it is required to be above a pre-set threshold for DNA recovery). If readily available, source material for Extraction Positive Controls is matched to the specimen source type. Exception: The Extraction Positive Control for bone marrow specimens consists of frozen human whole blood.

PCR Amplification Process Controls

Each PCR amplification is performed with an Amplification Positive and Negative Control and subsequently sequenced in the same manner as test samples. The Amplification Positive Control consists of gDNA derived from blood mononuclear cells (PBMCs) and serves as an additional check to confirm successful product amplification. Buffer (1x TE) is used as the negative control.

Sequencing Process Controls

To every sequencing flow cell, two sequencing controls are added. Both a PhiX control purchased from Illumina and a well-characterized amplified library (Sequencing Positive Control) are loaded with test samples.

Result Reporting

The pipeline renders results into a PDF-formatted patient report. The report displays any ID sequences identified in the sample that can be used for tracking with their quantitation and sample-level metrics. For tracking tests, the report includes a result (ID sequences detected above LoD, below LoD, or not detected) and quantitation for the tracked sequences within the most recent sample.

Standards/Guidance Documents Referenced

CLSI guideline EP06-A Evaluation of the Linearity of Quantitative Measurement Procedures- A Statistical Approach.

Test Components

All reagents, materials, and equipment needed to perform the assay, with the exception of sample collection materials, are used exclusively at the Adaptive Biotechnologies single laboratory site. The clonoSEQ Assay is intended to be performed with serial number-controlled instruments qualified by Adaptive.

An ambient temperature sample shipper kit is available for use through Adaptive Clinical Services Team if requested by the ordering healthcare provider.

Sample Collection and Test Ordering

For clonoSEQ sample collection requirements and ordering information please visit:

www.adaptivebiotech.com/clonoseq/ordering

For detailed information regarding Performance Characteristics, please refer to FDA Decision Summary for clonoSEQ: https://www.accessdata.fda.gov/cdrh_docs/reviews/DEN170080.pdf

1 Instruments

The clonoSEQ Assay is intended to be performed using the:

- Illumina NextSeq™ 500/550 Systems (qualified by Adaptive Biotechnologies)

2 Performance Characteristics

2.1 Sample Storage and Shipment Stability

Specimens assessed by the clonoSEQ Assay were stable for the following storage conditions:

- At -15 °C to -25 °C for up to 18 months for BMA and up to 6 months for blood
- At 2 °C to 8 °C for up to 7 days for BMA and up to 14 days for blood
- At 15 °C to 25 °C for up to 3 days for BMA and up to 5 days for blood
- Up to 3 freeze/thaw cycles for BMA and blood

Specimens assessed by the clonoSEQ Assay were stable within the clonoSEQ shipper for ambient, summer and winter shipping conditions:

- For up to 4 days for BMA
- For up to 5 days for blood

2.2 Specimen Characterization

For bone marrow analytical studies, a panel of clinical specimens from 21 patients with ALL, 23 patients with MM and 22 patients with CLL was used for precision, quantitation accuracy and linearity studies. Sample types included bone marrow, BMBCs, CD138+ bone marrow cells, blood, and PBMCs. gDNA was isolated from these clinical samples and blended with gDNA isolated from healthy normal bone marrow to contrive specific MRD levels for the analytical studies.

Additionally, for blood analytical studies a panel of clinical specimens from 15 patients with CLL was used for precision, sensitivity and linearity studies. Sample types for CLL specimens included PBMCs and BMBCs. gDNA was isolated from these clinical samples and blended with gDNA isolated from normal healthy blood to contrive samples with specific MRD levels for the analytical studies. Clinical samples from all patients were characterized for presence, and frequency of diseased clones prior to use in these studies.

A study was performed to evaluate whether MRD estimates from blended gDNA were equivalent to MRD estimates from blended cells at known concentrations. The accuracy and linearity of sample MRD frequency was assessed at zero and across 11 MRD frequency levels ranging from 3.3×10^{-7} to 3.0×10^{-3} for both blended gDNA and gDNA extracted from blended cells. These dilutions included levels below LoD and spanned the range of reportable MRD levels. The MRD estimates on gDNA blends were comparable to the MRD estimates of the blended cells they were intended to mimic. Therefore, the blended gDNA from the clinical samples were determined to be functionally equivalent to clinical specimens for use in specific analytical studies.

2.3 Extraction

Methods to isolate gDNA from bone marrow, bone marrow mononuclear cells (BMBCs), blood, PBMCs, formalin fixed paraffin embedded (FFPE) bone marrow clot slides, and bone marrow smear slides were evaluated for performance in the clonoSEQ Assay. Studies were performed to determine extraction equivalence across multiple extraction runs with 3 variables (extraction instrument, operator, and reagent lot). Based on the results of all extractions, the tested gDNA extraction variables (operator, instrument, extraction reagent lot, and extraction run) met acceptance criteria. gDNA isolated from FFPE bone marrow clot slides and bone marrow smear slides was only assessed for utility in identifying sequences and not MRD tracking.

2.4 Precision

Precision studies in BMA derived samples tested gDNA extracted from clinical specimens from 21 patients with ALL, 23 patients with MM, and 22 patients with CLL. The gDNA from these

specimens were used to contrive specific MRD levels by pooling and blending them into gDNA extracted from the BMA of healthy donors. The study included 3 DNA inputs (500 ng, 2 µg, 20 µg) and 6 MRD levels were tested at each DNA input for each patient sample. The studies were designed to test the target MRD levels of:

2.8x10⁻⁵, 8.0x10⁻⁵, 2.8x10⁻⁴, 8.0x10⁻⁴, 2.8x10⁻³ and 8.0x10⁻³ at 500 ng DNA input;
7.0x10⁻⁶, 2.0x10⁻⁵, 7.0x10⁻⁵, 2.0x10⁻⁴, 7.0x10⁻⁴ and 2.0x10⁻³ at 2 µg DNA input; and
7.0x10⁻⁷, 2.0x10⁻⁶, 7.0x10⁻⁶, 2.0x10⁻⁵, 7.0x10⁻⁵ and 2.0x10⁻⁴ at 20 µg DNA input.

These frequencies correspond to an estimated 2.14, 6.13, 21.44, 61.26, 214.40 and 612.56 malignant cells tested at each DNA dilution.

Precision studies in blood-derived samples tested gDNA extracted from clinical specimens from 15 patients with CLL. The gDNA from these specimens was used to contrive specific MRD levels by pooling and blending them into gDNA extracted from the blood of healthy donors. The study included 3 DNA inputs (500 ng, 2 µg, 20 µg) and multiple MRD levels were tested at each DNA input for each patient sample. The studies were designed to test the target MRD levels of:

4.0x10⁻⁵, 1.0x10⁻⁴, 4.0x10⁻⁴, 1.0x10⁻³ 4.0x10⁻³ at 500 ng DNA input;
1.0x10⁻⁵, 2.5x10⁻⁵, 1.0x10⁻⁴, 2.5x10⁻⁴, 1.0x10⁻³ for 2 µg DNA input; and
1.0x10⁻⁶, 2.5x10⁻⁶, 1.0x10⁻⁵, 2.5x10⁻⁵, 1.0x10⁻⁴, 2.5x10⁻⁴ at 20 µg DNA input.

These frequencies correspond to an estimated 3.06, 7.66, 30.63, 76.67, 306.28, and 765.70 malignant cells tested at each DNA dilution.

Both precision studies used a main effects screening design over 21 calendar days. This study used 10 runs, with 2 PCR plates each run, using 3 operator sets, 4 reagent lots, and 4 instrument sets (2 thermal cycler/liquid handlers and 2 NextSeq™ instruments). The study design for blood used both NextSeq 500 and 550s. The study design for BMA is summarized in **Figure 2** and for blood in **Figure 3**.

Figure 2: BMA Precision Study Design Schematic

clonoSEQ Assay: Precision Study PCR Run Execution Map

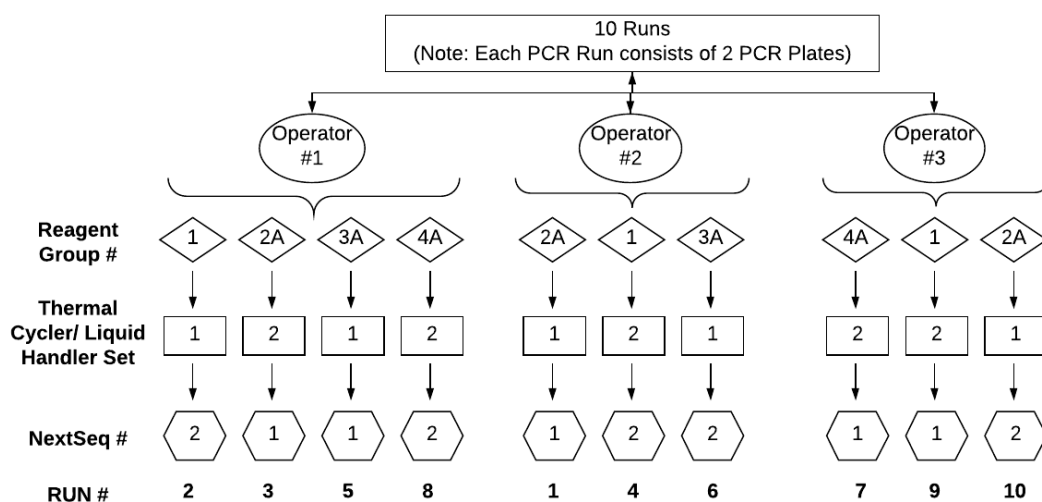
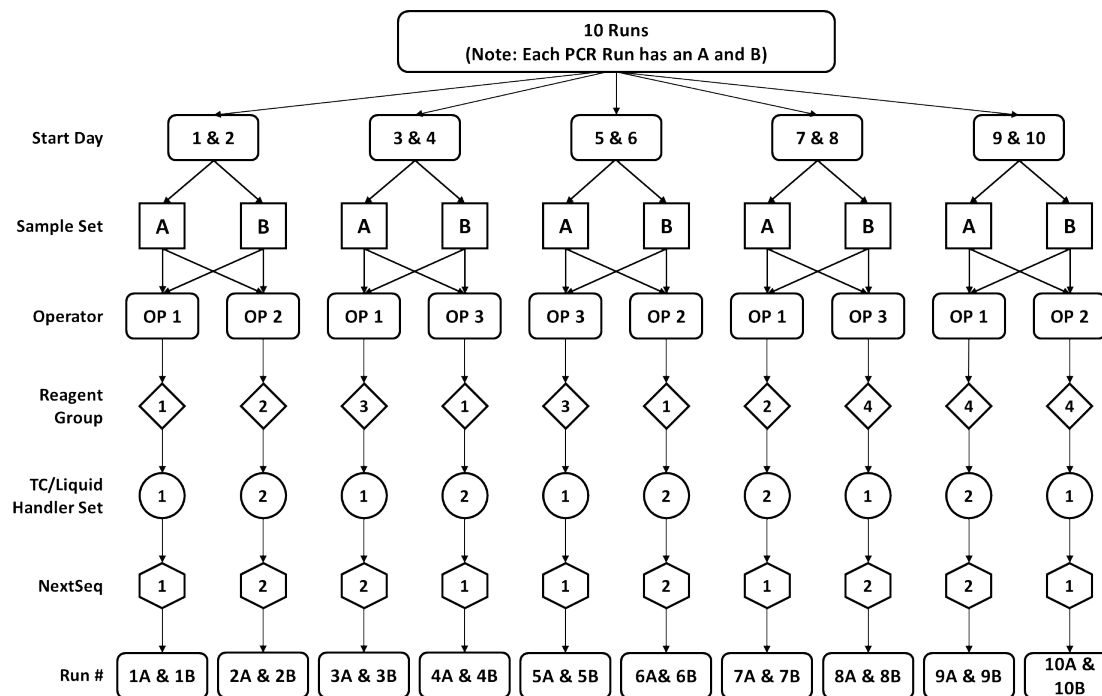

Figure 3: Blood Precision Study Design Schematic



For the BMA study, each run of the assay tested 18 combinations of DNA input and MRD frequency in duplicate. In all, 360 contrived samples were tested. Of these, one plate with 18 samples was invalid due to sample QC failures; the plate-level failure rate was therefore $1 / 20 = 0.05$. An additional two contrived samples (88 MRD measurements) failed sample QC due to insufficient sequencing coverage. While normal operating procedures permit re-sequencing, for this analysis these two samples were classified as failures. The analysis used the remaining 340 contrived samples with up to 66 MRD measurements per sample, for a total of 22,224 MRD measurements.

For the blood precision study, each run of the assay tested 16 combinations of gDNA input and MRD frequency, in duplicate, for a total of 320 contrived samples tested. There were no plate failures. One sample replicate was invalid due to sample QC failure, leaving 319 contrived samples and a total of 4,785 MRD measurements in the final analysis (15 MRD measurements x 319 samples).

In both BMA and blood sample types, the precision of the clonoSEQ Assay is largely dependent upon the number of malignant cells that are being evaluated rather than the MRD frequency. Consequently, the same MRD frequency is expected to have lower precision at lower gDNA inputs. For these studies, precision estimates were calculated based on the MRD frequency per gDNA input and estimates of imprecision of the absolute number of malignant cells detected were calculated.

Precision of MRD Frequency for ALL, MM and CLL in BMA

Precision analysis, including variation from instrument set, operator, processing day, processing run, and reagent lot, is reported as %CV for each tested MRD frequency at each DNA input. The analysis was done separately for ALL, MM and CLL and are summarized in **Table 1**, **Table 2** and **Table 3**. Precision ranged from 25.9% to 76.9% CV for ALL, 29.5% to 70.0% CV for MM and 18.5% to 60.1% for CLL.

In these tables, MRD frequency range refers to the central 95% range of MRD estimates that were observed across all of the patient samples tested at each DNA input and frequency condition. These data were used to define the 95% confidence intervals that are used in patient reports.

Table 1: Precision of the clonoSEQ Assay in ALL BMA Samples

DNA Input	Target MRD Frequency	Measurements	Patients	%CV	Mean MRD Frequency	Frequency range (95% CI)
500 ng	2.8×10^{-5}	378	21	76.9	3.2×10^{-5}	0 - 9.3×10^{-5}
	8.0×10^{-5}	378	21	54.1	8.6×10^{-5}	1.0×10^{-5} - 1.9×10^{-4}
	2.8×10^{-4}	378	21	33.0	2.8×10^{-4}	1.0×10^{-4} - 4.8×10^{-4}
	8.0×10^{-4}	420	21	29.3	7.6×10^{-4}	3.4×10^{-4} - 1.2×10^{-3}
	2.8×10^{-3}	420	21	26.5	2.5×10^{-3}	1.0×10^{-3} - 4.0×10^{-3}
	8.0×10^{-3}	420	21	25.9	6.0×10^{-3}	2.2×10^{-3} - 9.8×10^{-3}
2 µg	7.0×10^{-6}	378	21	74.1	7.6×10^{-6}	0 - 2.0×10^{-5}
	2.0×10^{-5}	378	21	47.4	2.1×10^{-5}	3.8×10^{-6} - 4.0×10^{-5}
	7.0×10^{-5}	378	21	33.3	6.8×10^{-5}	2.2×10^{-5} - 1.1×10^{-4}
	2.0×10^{-4}	420	21	29.1	1.9×10^{-4}	7.0×10^{-5} - 3.1×10^{-4}
	7.0×10^{-4}	420	21	27.1	6.8×10^{-4}	2.5×10^{-4} - 1.1×10^{-3}
	2.0×10^{-3}	420	21	25.9	1.9×10^{-3}	6.9×10^{-4} - 3.1×10^{-3}
20 µg	7.0×10^{-7}	378	21	74.8	8.5×10^{-7}	0 - 2.2×10^{-6}
	2.0×10^{-6}	378	21	49.8	2.3×10^{-6}	4.0×10^{-7} - 4.7×10^{-6}
	7.0×10^{-6}	378	21	34.5	7.5×10^{-6}	2.6×10^{-6} - 1.3×10^{-5}
	2.0×10^{-5}	420	21	27.9	2.1×10^{-5}	8.5×10^{-6} - 3.4×10^{-5}
	7.0×10^{-5}	420	21	26.7	6.9×10^{-5}	2.5×10^{-5} - 1.1×10^{-4}
	2.0×10^{-4}	378	21	26.5	2.0×10^{-4}	7.1×10^{-5} - 3.3×10^{-4}

Table 2: Precision of the clonoSEQ Assay in MM BMA Samples

DNA Input	Target MRD Frequency	Measurements	Patients*	%CV	Mean MRD Frequency	Frequency Range (95% CI)
500 ng	2.8×10^{-5}	378	21	70.0	3.5×10^{-5}	0 - 9.0×10^{-5}
	8.0×10^{-5}	378	21	52.6	8.9×10^{-5}	1.9×10^{-5} - 2.0×10^{-4}

DNA Input	Target MRD Frequency	Measurements	Patients*	%CV	Mean MRD Frequency	Frequency Range (95% CI)
	2.8x10 ⁻⁴	414	23	37.6	3.0x10 ⁻⁴	1.2x10 ⁻⁴ - 5.7x10 ⁻⁴
	8.0x10 ⁻⁴	460	23	34.8	8.4x10 ⁻⁴	3.9x10 ⁻⁴ - 1.6x10 ⁻³
	2.8x10 ⁻³	460	23	32.3	2.7x10 ⁻³	1.4x10 ⁻³ - 5.1x10 ⁻³
	8.0x10 ⁻³	460	23	30.1	6.5x10 ⁻³	3.6x10 ⁻³ - 1.2x10 ⁻²
2 µg	7.0x10 ⁻⁶	378	21	69.2	8.1x10 ⁻⁶	0 - 2.1x10 ⁻⁵
	2.0x10 ⁻⁵	378	21	52.1	2.3x10 ⁻⁵	5.7x10 ⁻⁶ - 5.4x10 ⁻⁵
	7.0x10 ⁻⁵	414	23	38.8	7.8x10 ⁻⁵	3.1x10 ⁻⁵ - 1.5x10 ⁻⁴
	2.0x10 ⁻⁴	460	23	34.4	2.1x10 ⁻⁴	1.0x10 ⁻⁴ - 4.0x10 ⁻⁴
	7.0x10 ⁻⁴	460	23	32.4	7.4x 0 ⁻⁴	3.7x10 ⁻⁴ - 1.4x10 ⁻³
	2.0x10 ⁻³	460	23	30.2	2.0x10 ⁻³	1.1x10 ⁻³ - 3.8x10 ⁻³
20 µg	7.0x10 ⁻⁷	378	21	65.6	8.6x10 ⁻⁷	0 - 2.1x10 ⁻⁶
	2.0x10 ⁻⁶	378	21	51.7	2.3x10 ⁻⁶	5.1x10 ⁻⁷ - 5.0x10 ⁻⁶
	7.0x10 ⁻⁶	414	23	37.2	8.2x10 ⁻⁶	3.5x10 ⁻⁶ - 1.5x10 ⁻⁵
	2.0x10 ⁻⁵	460	23	33.3	2.3x10 ⁻⁵	1.2x10 ⁻⁵ - 4.5x10 ⁻⁵
	7.0x10 ⁻⁵	460	23	31.1	7.6x10 ⁻⁵	4.1x10 ⁻⁵ - 1.4x10 ⁻⁴
	2.0x10 ⁻⁴	414	23	29.5	2.1x10 ⁻⁴	1.2x10 ⁻⁴ - 3.7x10 ⁻⁴

Note: Some contrived samples included a subset of patient samples.

Table 3: Precision of the clonoSEQ Assay in CLL BMA Samples

DNA Input	Target MRD Frequency	Measurements	Patients*	%CV	Mean MRD Frequency	Frequency Range (95% CI)
500 ng	2.8x10 ⁻⁵	396	22	57.9	4.4 x 10 ⁻⁵	0 - 1.0 x 10 ⁻⁴
	8.0x10 ⁻⁵	396	22	42.5	1.0 x 10 ⁻⁴	3.4 x 10 ⁻⁵ - 2.0 x 10 ⁻⁴
	2.8x10 ⁻⁴	396	22	28.1	3.4 x 10 ⁻⁴	1.7 x 10 ⁻⁴ - 5.6 x 10 ⁻⁴
	8.0x10 ⁻⁴	440	22	24.3	9.2 x 10 ⁻⁴	5.6 x 10 ⁻⁴ - 1.5 x 10 ⁻³
	2.8x10 ⁻³	440	22	21.2	2.9 x 10 ⁻³	1.9 x 10 ⁻³ - 4.4 x 10 ⁻³
	8.0x10 ⁻³	440	22	19.5	7.1 x 10 ⁻³	4.5 x 10 ⁻³ - 1.0 x 10 ⁻²
2 µg	7.0x10 ⁻⁶	396	22	60.2	1.0 x 10 ⁻⁵	0 - 2.4 x 10 ⁻⁵
	2.0x10 ⁻⁵	396	22	44.7	2.6 x 10 ⁻⁵	9.3 x 10 ⁻⁶ - 5.4 x 10 ⁻⁵
	7.0x10 ⁻⁵	396	22	28.9	8.5 x 10 ⁻⁵	4.5 x 10 ⁻⁵ - 1.4 x 10 ⁻⁴
	2.0x10 ⁻⁴	440	22	23.5	2.3 x 10 ⁻⁴	1.4 x 10 ⁻⁴ - 3.8 x 10 ⁻⁴
	7.0x10 ⁻⁴	440	22	21.4	8.2 x 10 ⁻⁴	5.1 x 10 ⁻⁴ - 1.3 x 10 ⁻³
	2.0x10 ⁻³	440	22	19.2	2.2 x 10 ⁻³	1.4 x 10 ⁻³ - 3.2 x 10 ⁻³
20 µg	7.0x10 ⁻⁷	396	22	59.9	1.1 x 10 ⁻⁶	0 - 2.6 x 10 ⁻⁶
	2.0x10 ⁻⁶	396	22	41.2	2.9 x 10 ⁻⁶	1.0 x 10 ⁻⁶ - 5.6 x 10 ⁻⁶
	7.0x10 ⁻⁶	396	22	27.2	9.1 x 10 ⁻⁶	5.4 x 10 ⁻⁶ - 1.5 x 10 ⁻⁵

DNA Input	Target MRD Frequency	Measurements	Patients*	%CV	Mean MRD Frequency	Frequency Range (95% CI)
	2.0x10 ⁻⁵	440	22	22.8	2.6 x 10 ⁻⁵	1.6 x 10 ⁻⁵ - 3.9 x 10 ⁻⁵
	7.0x10 ⁻⁵	440	22	20.1	8.4 x 10 ⁻⁵	5.2 x 10 ⁻⁵ - 1.2 x 10 ⁻⁴
	2.0x10 ⁻⁴	396	22	26.7	2.3 x 10 ⁻⁴	1.6 x 10 ⁻⁴ - 3.3 x 10 ⁻⁴

Note: Some contrived samples included a subset of patient samples.

Precision of MRD Frequency for CLL in blood

Precision analysis, including variation from instrument set, operator, processing day, processing run, and reagent lot, is reported as %CV for each tested MRD frequency at each DNA input. The analysis for CLL is summarized in

Table 4. Precision ranged from 18.7% to 54.9% CV in CLL.

The measured % CV of the assay for CLL blood samples in this study (**Table 4**) was found to be comparable to the previously measured %CV in ALL, MM and CLL bone marrow samples.

Table 4: Precision of the clonoSEQ Assay in CLL Blood

DNA Input	Target MRD Frequency	Measurements	Patients	%CV	Mean MRD Frequency	Frequency Range (95% CI)
500 ng	4.0x10 ⁻⁵	300	15	54.9	5.3x10 ⁻⁵	1.1x10 ⁻⁵ - 1.2x10 ⁻⁴
	1.0x10 ⁻⁴	300	15	38.3	1.2x10 ⁻⁴	4.1x10 ⁻⁵ - 2.2x10 ⁻⁴
	4.0x10 ⁻⁴	300	15	28.9	4.4x10 ⁻⁴	2.3x10 ⁻⁴ - 7.1x10 ⁻⁴
	1.0x10 ⁻³	285	15	24.4	1.1x10 ⁻³	6.4x10 ⁻⁴ - 1.7x10 ⁻³
	4.0x10 ⁻³	300	15	21.9	4.3x10 ⁻³	2.8x10 ⁻³ - 6.3x10 ⁻³
2 µg	1.0x10 ⁻⁵	300	15	51.6	1.2x10 ⁻⁵	2.4x10 ⁻⁶ - 2.7x10 ⁻⁵
	2.5x10 ⁻⁵	300	15	37.3	2.9x10 ⁻⁵	1.1x10 ⁻⁵ - 5.2x10 ⁻⁵
	1.0x10 ⁻⁴	300	15	26.5	1.1x10 ⁻⁴	6.1x10 ⁻⁵ - 1.7x10 ⁻⁴
	2.5x10 ⁻⁴	300	15	23.0	2.7x10 ⁻⁴	1.7x10 ⁻⁴ - 4.0x10 ⁻⁴
	1.0x10 ⁻³	300	15	20.8	1.1x10 ⁻³	6.8x10 ⁻⁴ - 1.6x10 ⁻³
20 µg	1.0x10 ⁻⁶	300	15	49.2	1.3x10 ⁻⁶	2.9x10 ⁻⁷ - 2.8x10 ⁻⁶
	2.5x10 ⁻⁶	300	15	36.4	2.9x10 ⁻⁶	1.2x10 ⁻⁶ - 5.3x10 ⁻⁶
	1.0x10 ⁻⁵	300	15	25.9	1.1x10 ⁻⁵	6.6x10 ⁻⁶ - 1.8x10 ⁻⁵
	2.5x10 ⁻⁵	300	15	23.0	2.7x10 ⁻⁵	1.7x10 ⁻⁵ - 4.3x10 ⁻⁵
	1.0x10 ⁻⁴	300	15	19.5	1.1x10 ⁻⁴	7.5x10 ⁻⁵ - 1.6x10 ⁻⁴

DNA Input	Target MRD Frequency	Measurements	Patients	%CV	Mean MRD Frequency	Frequency Range (95% CI)
	2.5x10 ⁻⁴	300	15	18.7	2.7x10 ⁻⁴	1.9x10 ⁻⁴ - 3.9x10 ⁻⁴

Precision of Malignant Cells Detected in BMA

The precision of malignant cells detected was evaluated across the range of tested malignant cells (2.14 – 612.56). For this analysis, the results from all of the DNA inputs across ALL, MM and CLL were pooled into a single analysis that is summarized in Table 5. As expected, the precision was primarily influenced by cell numbers being evaluated. Precision ranged from 68% CV at 2.14 cells to 19% CV at 612.56 cells. The majority of the observed variation is due to residual variability; the tested factors (Operator, Instrument Sets, Reagent Lots, Day, and Run) minimally contributed to variability with attributable %CV ranging from 0% to 3% (Table 5).

Table 5: Summary of the clonoSEQ Assay Precision in BMA

		%CV Attributed to Each Variable at Cell Inputs*					
		2.14	6.13	21.44	61.26	214.4	612.56
	# of Input Cancer Cells						
	Instrument Set	0%	1%	0%	1%	1%	1%
	Operator	2%	0%	1%	2%	0%	0%
	Processing Day	0%	0%	1%	1%	0%	3%
	Processing Run	0%	0%	1%	0%	0%	0%
Lot-to-Lot Variability	Reagent Lot	0%	0%	0%	1%	2%	1%
	Residual Variability	68%	49%	28%	23%	19%	18%
Precision		68%	49%	28%	23%	19%	19%
N	Total MRD Measurements	3456	3456	3564	3960	3960	3828

* These values were aggregated across diseases (ALL, MM and CLL) and total DNA input levels

The precision for each sample at each tested condition across all DNA inputs is summarized in a Sadler’s precision profile (Figure 4). The Sadler’s precision profile visualizes the relationship between the number of sampled malignant cells and precision as measured by %CV. This analysis demonstrates that the precision of the clonoSEQ Assay is largely dependent on the number of malignant cells that are being evaluated by the assay.

Figure 4: Sadler’s Precision Profile (Coefficient of Variation) of the clonoSEQ Assay as a Function of Input Cancer Cells in BMA

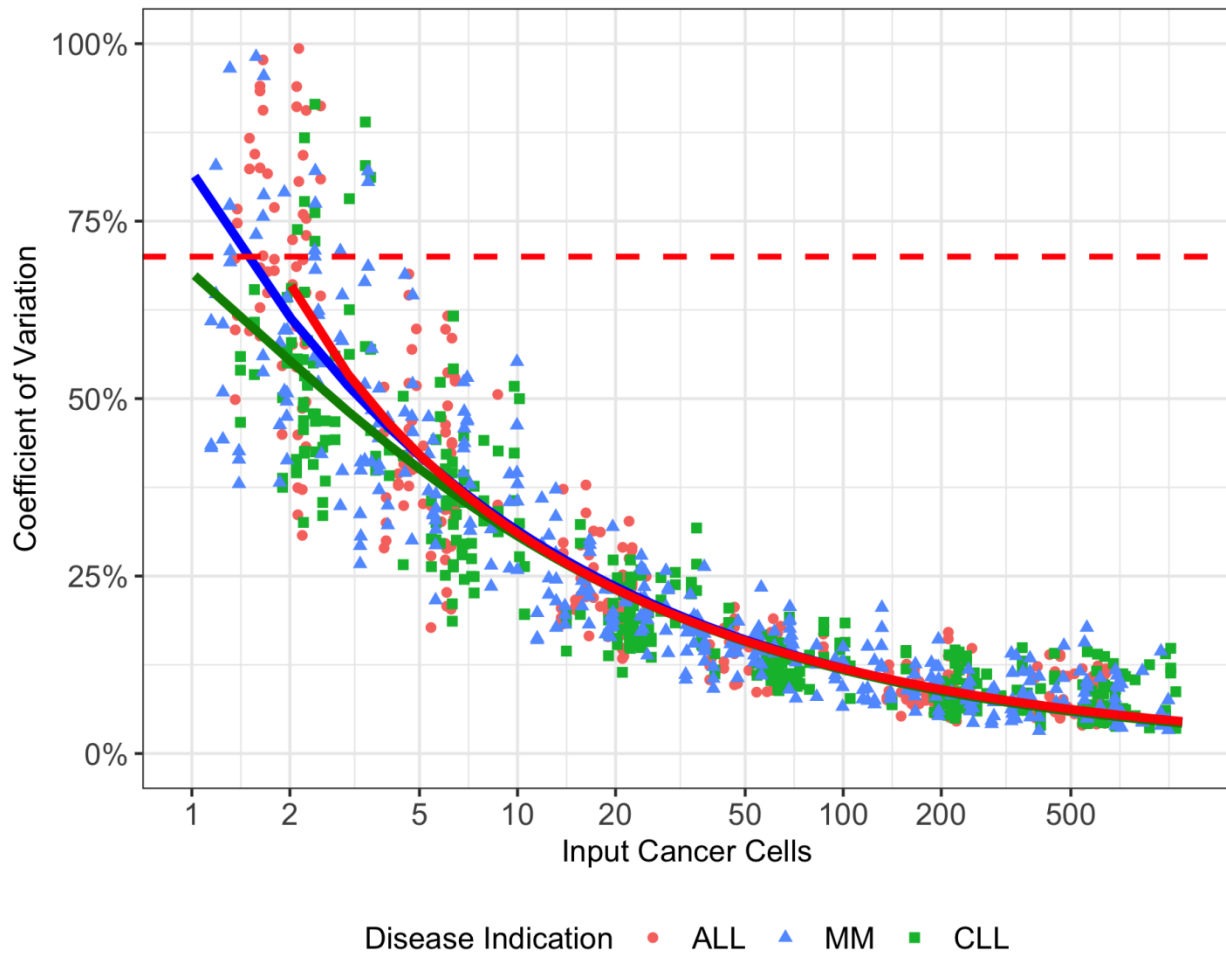

Precision of Malignant Cells Detected for CLL in blood

The precision of malignant cells detected in blood was evaluated across the range of tested malignant cells (3.10 – 765.70). The results from all of the DNA inputs for CLL are summarized in **Table 6**.

Precision ranged from 53% CV at 3.10 cells to 19% CV at 765.70 cells. The majority of the observed variation is due to residual variability. DNA input mass contributed to variability with attributable %CV ranging from 8% to 10%, and the pre-specified test factors (Operator, Instrument Sets, Reagent Lots, Day, and Run) minimally contributed to variability, with attributable %CV ranging from 0% to 3% (**Table 6**).

Table 6: Summary of the clonoSEQ Assay Precision in CLL Blood

		%CV Attributed to Each Variable at Cell Inputs					
	# of Input Cancer Cells	3.06	7.66	30.63	76.57	306.28	765.70
	Instrument Set	0%	0%	0%	0%	0%	0%
	Operator	0%	0%	0%	0%	0%	0%
	Processing Day	0%	3%	2%	0%	0%	0%
	Processing Run	0%	0%	1%	0%	0%	0%
	DNA Input	10%	10%	10%	8%	8%	NA
Lot-to-Lot variability	Reagent Lot	2%	0%	2%	0%	0%	0%
	Residual variability	52%	37%	27%	23%	21%	19%
Precision		53%	39%	29%	25%	22%	19%
N	Total MRD Measurements	900	900	900	885	900	300

The precision for each sample at each tested condition across all DNA inputs is summarized in a Sadler’s precision profile (**Figure 5**). The Sadler’s precision profile visualizes the relationship between the number of sampled malignant cells and precision as measured by %CV (note the inclusion of a lower input to align with the BMA plot). This analysis demonstrates that, like BMA, the precision of the clonoSEQ Assay in CLL blood is largely dependent on the number of malignant cells that are being evaluated by the assay.

Figure 5: Sadler’s Precision Profile (Coefficient of Variation) of the clonoSEQ Assay as a Function of Input CLL Cancer Cells in Blood

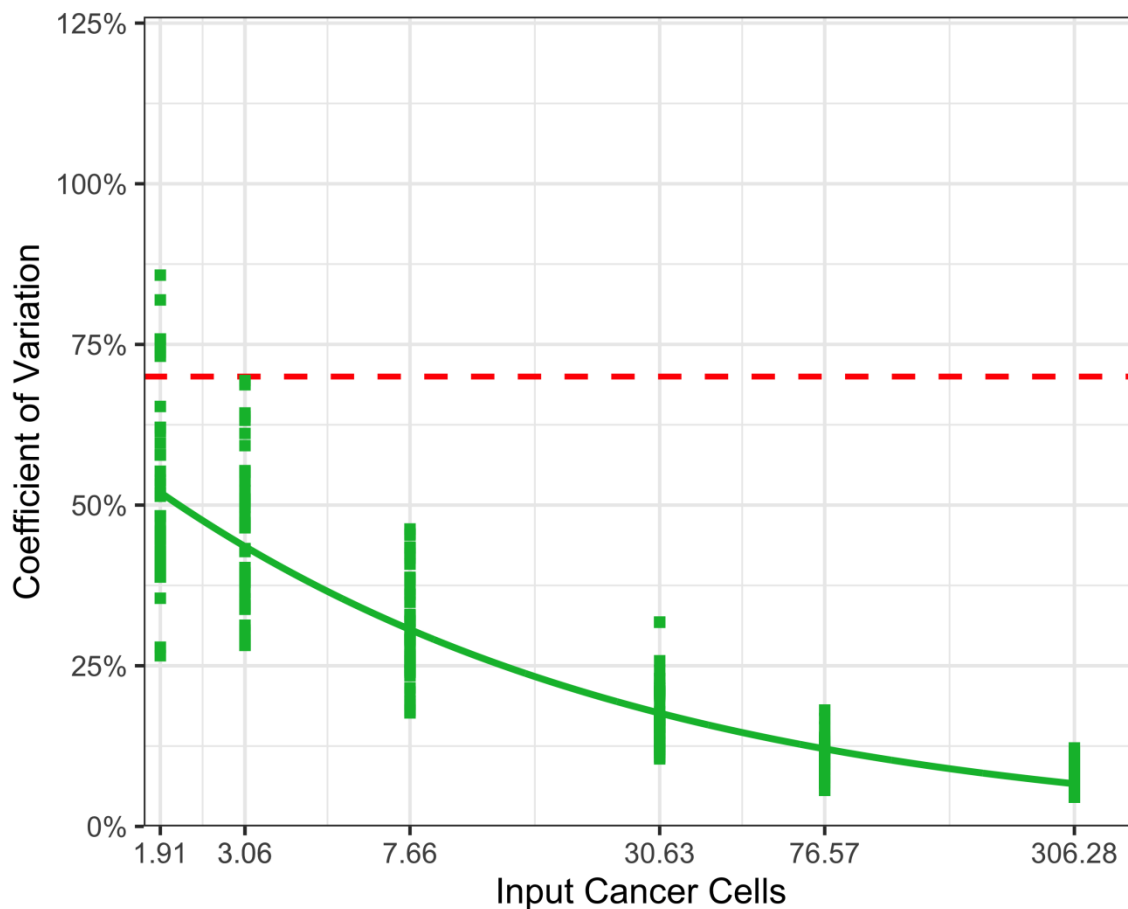

Precision of the clonoSEQ Assay is comparable in blood and bone marrow in CLL.

2.5 Analytical Sensitivity

2.5.1 Limit of Blank

The LoB was determined by measuring the specificity of a patient’s trackable immunoglobulin (Ig) sequences. These sequences were identified from 66 samples from patients diagnosed with a lymphoid malignancy (23 MM, 21 ALL, and 22 CLL). The LoB was determined by searching for the presence and abundance of these trackable sequences in healthy bone marrow samples. The 95th percentile of sample MRD frequencies for these trackable sequences was zero at 500 ng, 20 µg, and 40 µg of gDNA input. Therefore, the LoB was zero, demonstrating that trackable Ig sequences are highly patient-specific.

Similarly, the LoB in samples derived from blood was verified by searching for the presence and abundance of the trackable sequences from 15 samples from patients with CLL. The presence and abundance of these trackable sequences in healthy blood was assessed. The LoB was

confirmed as zero in blood, based on the 95th percentile of sample MRD frequencies at 500 ng, 20 ug and 40 ug inputs.

2.5.2 Limit of Detection/Limit of Quantitation

For bone marrow samples, the LoD and LoQ were determined by blending gDNA extracted from 66 specimens from patients with lymphoid malignancies (21 ALL, 23 MM and 22 CLL) into 500 ng and 20 µg of gDNA from bone marrow. A dilution series of 22.97, 10.72, 4.59, 2.14 and 0.94 malignant cell equivalents was made for each patient at each DNA input level. Each sample was tested in duplicate for each of 4 reagent lots resulting in eight results for each of the 66 samples at each dilution condition. A probit approach was used to determine the LoD to be 1.903 malignant cells (95% CI; 1.75 – 2.07) based on the combined data from both DNA inputs (**Table 7**). The LoQ was defined as the lowest absolute number of malignant cells whose frequency can be quantitatively determined with an accuracy of 70% relative total error. The LoQ was found to be 2.390 malignant cells (95% CI; 1.90 – 9.14) (**Table 7**).

Table 7: LoD/LoQ in BMA by MRD Cell Counts and by MRD Frequency

Measure	Malignant Cells*	500 ng DNA Input Frequency (95% CI)	20 µg DNA Input Frequency (95% CI)
LoD	1.903 (1.75 - 2.07)	2.26x10 ⁻⁵ (2.01x10 ⁻⁵ - 2.53x10 ⁻⁵)	6.77x10 ⁻⁷ (6.02x10 ⁻⁷ - 7.61x10 ⁻⁷)
LoQ	2.390 (1.90 - 9.14)	2.39x10 ⁻⁵ (2.26x10 ⁻⁵ - 7.01x10 ⁻⁵)	1.76 x 10 ⁻⁶ (6.77x10 ⁻⁷ - 4.09x10 ⁻⁶)

*Calculated from samples with 500 ng and 20 µg of DNA input.

The clonoSEQ Assay can use a range of DNA inputs from 500 ng to 40 µg of DNA. The LoD/LoQ by MRD frequency will vary based on the DNA input and the total nucleated cells that are evaluated by the assay. The estimated LoD/LoQ at 500 ng and 20 µg of DNA input from BMA are shown in **Table 7**.

To confirm the LoD and LoQ, 1.903 and 2.390 malignant cell equivalents were spiked into 200 ng, 500 ng, 1 µg, 2 µg, 5 µg, 10 µg, 20 µg, and 40 µg of gDNA extracted from bone marrow of healthy subjects. The results showed that the LoD and LoQ of malignant cells detected remained consistent across all DNA input levels.

The LoD and LoQ were similarly determined for the background matrix of blood. The gDNA extracted from 15 CLL patient specimens was mixed into 500 ng and 20 µg of gDNA from healthy donors of blood to achieve targeted disease levels. A dilution series of 30.63, 7.66, 3.06, 1.91 and 0.77 malignant cell equivalents was made for each CLL patient at each DNA input level. Each sample was tested in duplicate in each run, for each of 4 reagent lots, 3 operators and 2 sequencing instruments, resulting in twenty results for each of the 15 samples at each dilution condition. A probit approach was used to determine the LoD from all DNA inputs. The LoQ was calculated by applying the Sadler’s precision profile model to all non-zero MRD frequency

results for each indication. The estimated LoD/LoQ at 500ng and 20 µg of DNA input from blood are shown in **Table 8**.

Table 8: LoD/LoQ in Blood by MRD Cell Counts and by MRD Frequency

Measure	Malignant Cells*	500 ng DNA Input Frequency (95% CI)	20 µg DNA Input Frequency (95% CI)
LoD	1.317 (1.20 – 1.48)	2.66×10^{-5} (2.32×10^{-5} – 3.2×10^{-5})	4.62×10^{-7} (4.11×10^{-7} – 5.47×10^{-7})
LoQ	2.496 (1.40 – 3.88)	3.53×10^{-5} (2.85×10^{-5} – 4.15×10^{-5})	1.49×10^{-6} (3.83×10^{-7} – 2.71×10^{-6})

2.6 Analytical Specificity

2.6.1 Interfering Substances

Testing was performed to characterize the effects of 5 endogenous (**Table 9**) and 3 exogenous (**Table 10**) substances in BMA and blood samples on the clonoSEQ Assay to identify potential interfering substances. BMA was tested with K₂ EDTA, Chloroform and Heparin and blood was tested with K₂EDTA, K₃EDTA, and Heparin.

Table 9: Endogenous Interfering Substances Tested

Substance Name	Reference Level (Low)	Recommended Concentration (High)	Acceptance Criteria: Pass/Fail
Bilirubin conjugated	3.4 µmol/l	342 µmol/l	Pass
Bilirubin unconjugated*	21 µmol/l	342 µmol/l	Pass
Hemoglobin	1 g/l	2 g/l	Pass
Cholesterol*	5.2 mmol/l	13 mmol/l	Pass
Triglycerides	3.7 mmol/l	37 mmol/l	Pass

* Chloroform was used as solvent to resuspend bilirubin (unconjugated) and cholesterol.

Table 10: Exogenous Interfering Substances Tested

Substance Name	Concentration (Low)	Concentration (High)	Acceptance Criteria: Pass/Fail
K ₂ EDTA*	1.8 mg/ml	3.6 mg/ml	Pass
K ₃ EDTA ^Y	1.8 mg/ml	3.6 mg/ml	Pass
K ₃ EDTA ^Y	1.8 mg/ml	5.4 mg/ml	N/A ^Y
Heparin	15 USP U/µ	30 USP U/ml	Pass
Chloroform (solvent)†	2.5 µl	N/A	Pass

* BMA and blood samples were shipped to Adaptive containing 1.8 mg/ml EDTA (“Low” concentration) for anti-coagulation purposes. Additional EDTA was spiked in to achieve the High K₂EDTA level.

† Chloroform inhibition was tested at a single spiked-in volume (2.5 µl), in only bone marrow.

^YAssessed for healthy blood samples.

‡Assessed only for CLL patient blood samples. Assay performance with interferent was within assay variation at the baseline measurement.

The potential exogenous and endogenous substances were spiked separately into 250 µL aliquots of bone marrow or 2 µL blood from 4 different donors. Each condition was replicated for a total of eight times (4 donors with 2 replicates each) and all conditions passed the pre-specified MRD frequency equivalence margin of $\pm 30\%$. This study concluded that MRD results were not substantially influenced by the presence of the tested interfering substances in either blood or BMA.

An additional assessment of four CLL clinical blood specimens was performed with inclusion of K₃EDTA at low and high (3x) concentrations. The MRD results of both high and low K₃EDTA were within the confidence intervals of the baseline MRD measurement for all four CLL specimens. The assay performance with K₃EDTA in clinical samples was within assay variation at the baseline measurement

2.6.2 Cross-Contamination/Sample Carryover

The assessment of cross-contamination included multiple studies; one study to measure contamination of ID samples during automated DNA extraction of BMA and BMBCs, one study to measure contamination causing false ID or false MRD results in samples during automated DNA extraction of blood, and one study to measure contamination of DNA from MRD samples during PCR, library pooling, and sequencing with the clonoSEQ Assay.

Cross-contamination of ID samples during automated DNA extraction was assessed using a panel of lymphoid malignancy cell lines (3 ALL and 3 MM) each spiked to 10% of total cells in a BMA pool of 2 healthy subjects or a bone marrow mononuclear cell (BMBC) pool of 4 healthy subjects. PBS (blank) samples were included in this study. Samples were evaluated as to whether they correctly calibrated. There were no false calibrations for run-to-run with 0/44 BMA and 0/44 BMBC false calibrations. There was one false calibration for the well-to-well study with 1/44 BMA and 0/44 BMBC samples falsely calibrating. The falsely calibrated sequence was found in a PBS sample with 83 total templates and the sequence was not associated with any of the 6 cell lines. The PBS sample provided a sensitive test for contamination since there was no background DNA and a contamination of 83 templates would not be expected to cause false calibration of a clinical specimen.

Cross contamination during extraction of blood samples leading to incorrectly calling samples ID calibrated or MRD positive was determined using a panel of lymphoid malignancy cell lines (N=6), either individually spiked into background normal healthy blood at a 10% frequency, or by pooling the clinical cell line samples and spiking this pool into a background normal blood sample at a target of 10^{-5} PBS (blank) samples. Samples were evaluated for ID calibration results and MRD results. There were no contamination or disease clone-sharing events that resulted in false positive ID or MRD results.

Cross contamination of incorrectly calling samples MRD positive was assessed using gDNA from blood from healthy subjects as MRD-negative specimens and blends of cell line gDNA and

gDNA from blood of healthy subjects spiked to a concentration of 5%. The 5% level was used to simulate a patient with clinical relapse. This study evaluated for the presence of a clonal sequence and molecular barcode simultaneously. There were no run-to-run contamination events observed in 0/36 tests. Well-to-well cross contamination was observed in 8/712 comparisons; this was likely caused by contamination of a primer barcode plate sourced from a vendor. All contamination events were below 4×10^{-6} . This low level of contamination is unimpactful because tracked clonotype sequences are highly specific to each patient, so contamination between samples from different patients would not affect the reported MRD result. Cross contamination between samples from the same patient is prevented by process controls that disallow co-processing of samples from the same patient.

2.7 Linearity

Linearity of the clonoSEQ Assay using 3 ALL cell lines (SUP-B15, GM14952, and GM20930), 3 MM cell lines (IM9, U266, and L363), and 3 CLL cell lines (HG-3, MEC-1, and PGA-1) was evaluated by blending cell line gDNA with gDNA from healthy subjects using DNA inputs of 200 ng, 2 μ g and 20 μ g gDNA and tested at zero and across 11 MRD frequencies at each DNA input. This study was performed to measure the linearity of the clonoSEQ Assay at depths beyond the sensitivity of conventional tools. The frequency range of 6.0×10^{-5} to 1.0 was tested at the 200 ng DNA input. The frequency range of 6.5×10^{-6} to 1.0 was tested at the 2 μ g DNA input. The frequency range of 6.6×10^{-7} to 0.1 was tested at 20 μ g DNA input. The linear range of the assay was determined by finding the input range where the maximum deviation from linearity (based on a quadratic or cubic fit to the data) was less than 5%. Linearity was established for each sample input and disease type tested across the entire tested range (**Table 11**), with data shown in **Figure 6**. This study demonstrated linearity of MRD frequencies across several orders of magnitude for each condition tested.

Figure 6: Linearity of the clonoSEQ Assay in BMA. Expected (x-axis) and Observed (y-axis) MRD Frequency of 9 Cell Lines.

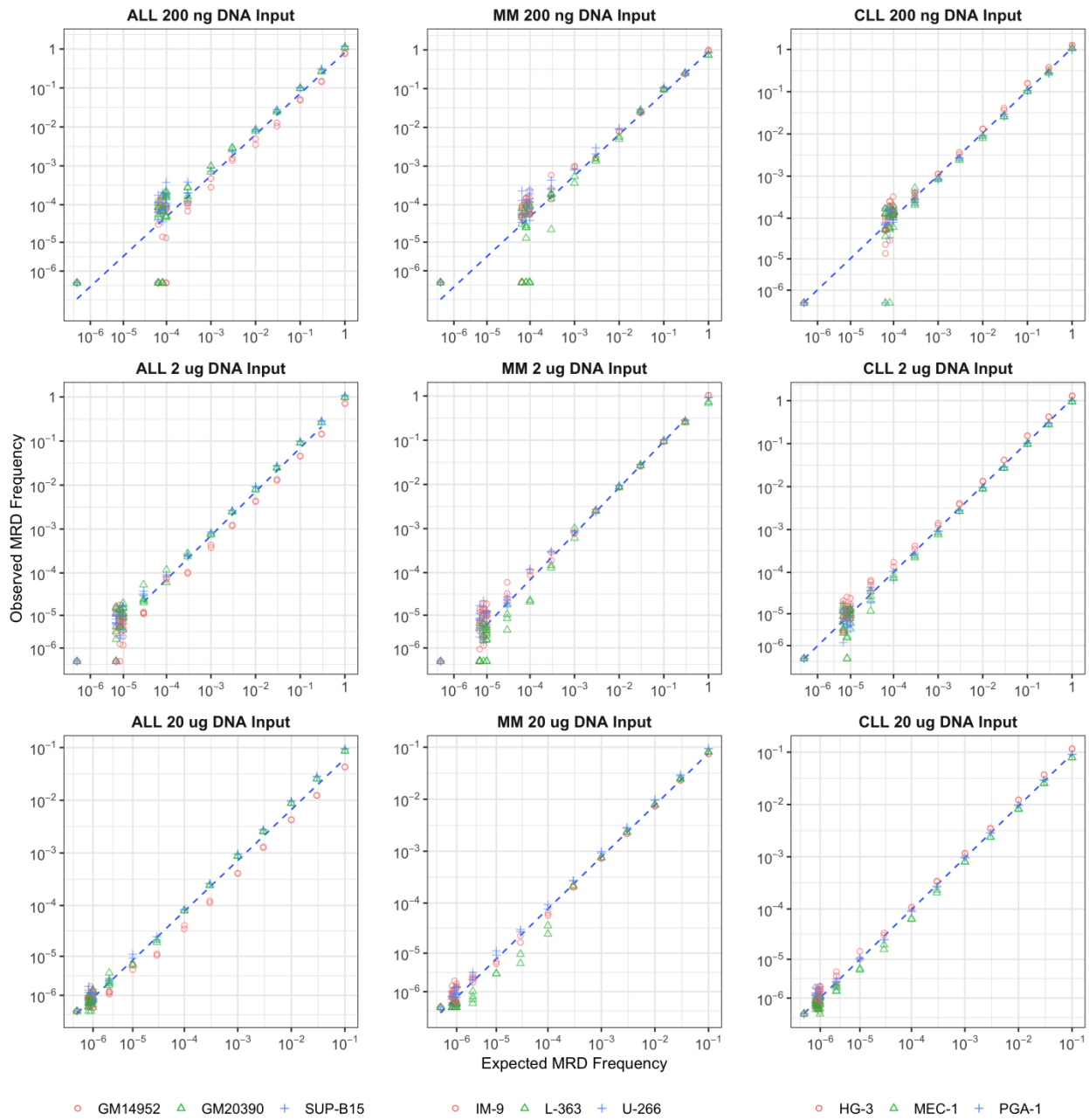

Table 11: Linearity of the clonoSEQ Assay in BMA using Cell Lines

Disease Indication	Input DNA	Tested Range	Combined Analysis			Summary of Individual Patient Analyses	
			Linear Range	Slope	Intercept	Slope Range	Intercept Range
ALL	200 ng	0 to 1	0 to 1	1.015	-0.109	0.988 to 1.047	-0.313 to 0.016
	2 µg	0 to 1	3.0x10 ⁻⁵ to 0.3	0.988	-0.172	0.976 to 0.996	-0.391 to -0.042
	20 µg	0 to 0.1	0 to 0.1	0.952	-0.262	0.882 to 0.991	-0.628 to -0.051
MM	200 ng	0 to 1	0 to 1	1.028	-0.066	0.978 to 1.113	-0.077 to -0.044
	2 µg	0 to 1	9.8x10 ⁻⁶ to 0.3	1.015	-0.033	0.985 to 1.064	-0.084 to 0.016
	20 µg	0 to 0.1	0 to 0.1	0.978	-0.145	0.960 to 0.993	-0.222 to -0.041
CLL	200 ng	0 to 1	0 to 1	0.994	0.018	0.978 to 1.011	-0.045 to 0.129
	2 ug	0 to 1	0 to 1	1.004	0.034	0.998 to 1.016	-0.045 to 0.161
	20 ug	0 to 0.1	0 to 0.1	0.994	-0.033	0.974 to 1.019	-0.159 to 0.111

Linearity using Clinical BMA Specimens

Linearity was confirmed using clinical samples from the precision study (Section 2.4), which evaluated blended gDNA extracted from 21 ALL, 23 MM and 22 CLL specimens at 3 DNA inputs and 6 MRD frequencies per DNA input. These data were re-analyzed to confirm linearity at the lower frequency range of the assay. The linear range of the assay was determined by finding the input range where the maximum deviation from linearity (based on a quadratic or cubic fit to the data) was less than 5%. Results are summarized in **Table 12**. The slopes and intercepts are reported as the average and range of values across all clinical specimens that were tested at each DNA input by disease indication. Results from 3 representative specimens for each ALL, MM and CLL are shown in **Figure 7**. This study demonstrated linearity across a wide range of MRD frequencies for each condition tested using clinical specimens.

Table 12: Linearity of clonoSEQ Assay in BMA using Clinical Specimens

Disease Indication	Input DNA	Tested Range	Combined Analysis			Summary of Individual Patient Analyses	
			Linear Range	Slope	Intercept	Slope Range	Intercept Range
ALL	500 ng	2.8×10^{-5} to 8.0×10^{-3}	2.8×10^{-5} to 8.0×10^{-3}	0.948	-0.214	0.853 to 1.073	-0.461 to 0.018
	2 µg	7.0×10^{-6} to 2.0×10^{-3}	7.0×10^{-6} to 2.0×10^{-3}	0.985	-0.074	0.909 to 1.076	-0.757 to 0.233
	20 µg	7.0×10^{-7} to 2.0×10^{-4}	7.0×10^{-7} to 2.0×10^{-4}	0.978	-0.101	0.859 to 1.029	-1.018 to 0.336
MM	500 ng	2.8×10^{-5} to 8.0×10^{-3}	2.8×10^{-5} to 8.0×10^{-3}	0.962	-0.143	0.853 to 1.148	-0.462 to 0.183
	2 µg	7.0×10^{-6} to 2.0×10^{-3}	7.0×10^{-6} to 2.0×10^{-3}	0.986	-0.04	0.924 to 1.068	-0.341 to 0.246
	20 µg	7.0×10^{-7} to 2.0×10^{-4}	7.0×10^{-7} to 2.0×10^{-4}	0.985	-0.034	0.933 to 1.075	-0.419 to 0.611
CLL	500ng	2.8×10^{-5} to 0.008	2.8×10^{-5} to 0.008	0.916	-0.216	0.847 to 1.004	-0.450 to 0.011
	2ug	7.0×10^{-6} to 0.002	7×10^{-6} to 0.002	0.964	-0.057	0.877 to 1.043	-0.358 to 0.248
	20ug	7.0×10^{-7} to 2.0×10^{-4}	7.0×10^{-7} to 2.0×10^{-4}	0.984	0.013	0.924 to 1.048	-0.417 to 0.272

Figure 7: Linearity of clonoSEQ Assay in BMA. The Expected (x-axis) and Observed (y-axis) MRD Frequency of 9 Clinical Samples

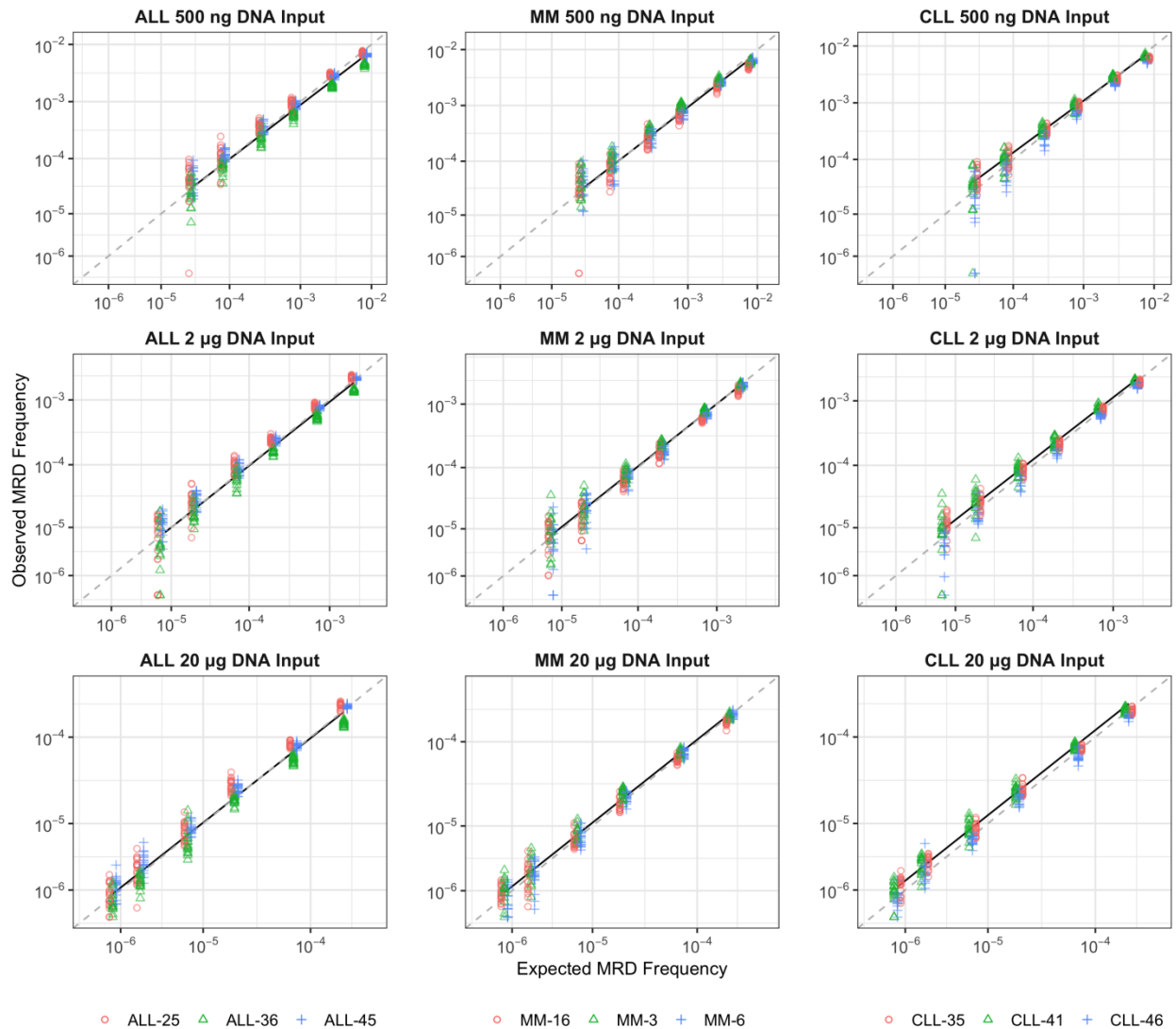

Linearity using Clinical Blood Specimens for CLL

Linearity was confirmed in blood using clinical samples from the precision study (Section 2.4), which evaluated blended gDNA extracted from 15 CLL specimens, at 3 DNA inputs and 6 MRD frequencies per DNA input. The linear range of the assay was determined by finding the input range where the maximum deviation from linearity (based on a quadratic or cubic fit to the data) was less than 5%. Results are summarized in **Table 13**. The slopes and intercepts are reported as the average and range of values across all clinical specimens that were tested at each DNA input. Results are shown in **Figure 8**. This study demonstrated linearity across a wide range of MRD frequencies using clinical blood specimens.

Table 13: Linearity using Clinical CLL Blood Specimens.

Disease Indication	Input DNA	Tested Range	Combined Analysis			Summary of Individual Patient Analyses	
			Linear Range	Slope	Intercept	Slope Range	Intercept Range
CLL	20ug	0 to 1×10^{-3}	0 to 1×10^{-3}	0.997	-0.009	0.942 to 1.044	-0.515 to 0.51
	2ug	0 to 1×10^{-3}	0 to 1×10^{-3}	0.995	-0.030	0.93 to 1.049	-0.78 to 0.53
	500ng	0 to 4×10^{-3}	0 to 4×10^{-3}	0.989	-0.075	0.941 to 1.092	-0.628 to 0.872

Figure 8: Linearity of the clonoSEQ Assay in CLL Blood. The Expected (x-axis) and Observed (y-axis) MRD Frequency of 15 Clinical Samples.

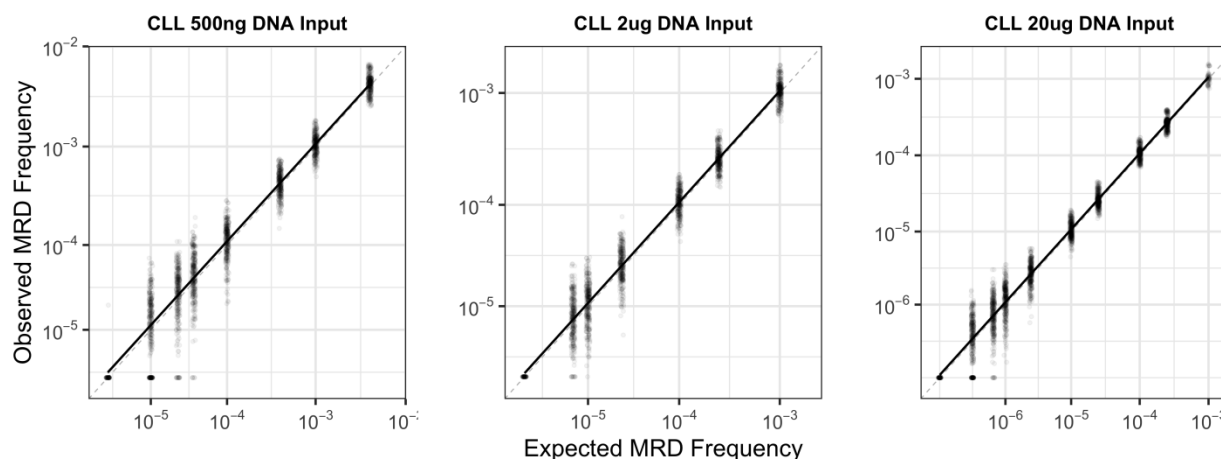

2.8 Reagent Stability

2.8.1 In-Use Reagent Stability

An in-use stability study was executed to determine stability needs of the clonoSEQ Assay for reaction mixes and intermediate steps. The following critical steps were evaluated: pre-amp and PCR primer mix stability, master mix stability, complete reaction stability, and process pause stability. gDNA was tested using seven replicates for all conditions tested. Acceptance criteria were based on sequencing results meeting all QC metrics; all of the conditions tested met the pre-specified acceptance criteria and the clonoSEQ Assay in-use stability needs.

2.8.2 Real Time Stability of Pre-Amp and PCR Mixes

The real-time reagent stability studies used the primer QC processes to assess primer performance and determine primer stability. The primer QC process uses a set of synthetic double-stranded molecules representing rearrangements of the targeted exons to determine whether each manufactured lot of pre-amp PCR primers and PCR primers are performing within specification. The priming sites on synthetic molecules are identical to biologic priming sites on targeted exons. Data from these molecules were analyzed and assessed for the ability of the

primers to amplify each identified exon at acceptable levels and the presence of primer sequences. These data were used to confirm that the performance of the pre-amp and PCR primers was adequate and consistent with previous primer lots. The performance of the amplification of the synthetic molecules met the pre-specified acceptance criteria. This real-time reagent stability study established a 15-month shelf life of pre-amp and PCR primer mixes when stored at -20 ± 5 °C. These data were confirmed by assessing the equivalence of MRD frequency in 40 clinical samples amplified with primer lots of different ages, and by tracking the stability of MRD measurements of synthetic molecules over time. The conditions tested in the real time stability study met the pre-specified acceptance criteria of a pairwise equivalence test of clinical specimens to be within $\pm 30\%$ MRD frequency.

2.9 Accuracy

2.9.1 Quantitation Accuracy

The analytical quantitation accuracy of the clonoSEQ Assay for MRD testing was assessed relative to multiparametric flow cytometry (mpFC):

- Assessment of the clonoSEQ Assay accuracy in cell mixtures compared to mpFC
- Concordance of the clonoSEQ Assay and mpFC in 2 clinical validation studies using bone marrow: ALL and MM
- Concordance of the clonoSEQ Assay with mpFC in clinical validation study using blood from CLL patients.
- Assessment of the clonoSEQ Assay accuracy in 66 clinical samples

2.9.2 Assessment of clonoSEQ Assay Accuracy in Cell Mixtures Compared to mpFC

Accuracy was assessed using cell line blends. Measured MRD frequencies were compared against known frequencies based on diluting cell lines into background mononuclear cells at specific MRD levels. The mpFC lab screened a panel of cancer cell lines and selected 2 MM and 2 ALL cancer cell lines that performed well with mpFC.

This study evaluated 2 MM cell lines (U266B1 and NCI-H929) and 2 ALL cell lines (SUP-B15 and GM20390); the mpFC laboratory screened a panel of cancer cell lines and selected these 4 cell lines based on performance of the mpFC assay. Each cell line was tested at five dilutions from 5×10^{-7} to 1×10^{-2} . Two replicates of each sample were assessed by the clonoSEQ Assay and mpFC. A pairwise comparison of MRD frequency measurements is shown in **Figure 9**. This study demonstrated similar quantitative accuracy comparing clonoSEQ with mpFC at frequencies above 1×10^{-4} .

Figure 9: Pairwise Comparison of MRD Frequency Measurements from mpFC (x-axis) and the clonoSEQ Assay (y-axis)

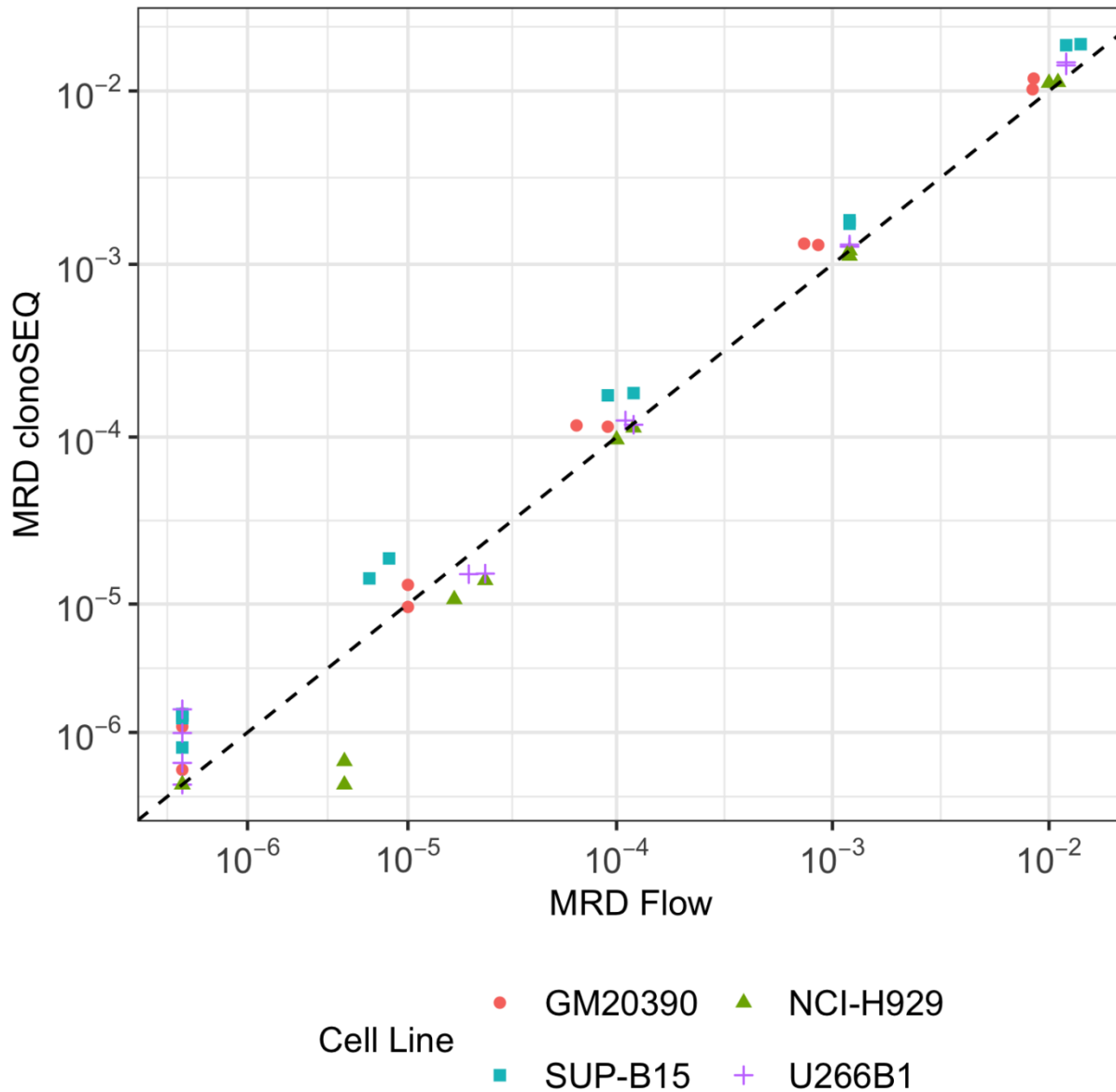

2.9.3 Concordance with mpFC in Bone Marrow Clinical Samples

Two concordance studies between mpFC and the clonoSEQ Assay were performed using clinical samples. For both studies concordance was assessed two ways: concordance of MRD positive or negative calls and concordance of reported MRD frequency. One study used 273 ALL samples from the Children’s Oncology Group (COG) AALL0331 (standard risk) and AALL0232 (high risk) regimens and compared the clonoSEQ Assay to a validated mpFC assay. The other study performed a similar comparison using 91 MM samples from the Dana Farber Cancer Institute (DFCI) Study 10-106 that were measured by both the clonoSEQ Assay and mpFC. MRD negativity was defined as $< 1 \times 10^{-4}$ for mpFC in ALL (a commonly used threshold in that patient

population) and $<1 \times 10^{-5}$ for mpFC in MM. For the clonoSEQ Assay, MRD calls were assessed at the LOD in both studies. The positive percent agreement (PPA) between the clonoSEQ Assay and mpFC was 93.5% for ALL and 97.9% for MM. Negative percent agreement (NPA) reflects the higher sensitivity of the clonoSEQ Assay with 117 ALL and 23 MM cases reported as positive for clonoSEQ and negative for mpFC (**Table 14**).

Table 14: Summary of mpFC vs. the clonoSEQ Assay Concordance Data for ALL and MM

	clonoSEQ+ mpFC+	clonoSEQ+ mpFC-	clonoSEQ- mpFC+	clonoSEQ- mpFC-	mpFC reference	
					NPA	PPA
ALL	43	117	3	110	48.5% (41.8- 55.2%)	93.5% (82.1- 98.6%)
MM	46	23	1	21	47.7% (32.5- 63.3%)	97.9% (88.7- 99.9%)

Concordance of MRD frequency was visualized by plotting reported MRD frequency of mpFC against the clonoSEQ Assay for both MM and ALL (**Figure 10**). Concordance of MRD calls is indicated by color; blue circles indicate samples had concordant MRD positive calls, while orange triangles and red squares denote discordant calls, with orange triangles indicating that clonoSEQ identified the sample as MRD positive and red squares indicating that mpFC identified the sample as MRD positive. To simplify the plot, samples with concordant MRD negative calls were not plotted. To quantify the similarity of reported MRD frequencies, correlations were calculated for samples with either concordant MRD calls or mpFC positive calls; MRD frequencies were highly concordant (ALL, concordance correlation coefficient = 92.8%; MM, concordance correlation coefficient = 91.9%). These data demonstrate that at high disease burdens mpFC and clonoSEQ report similar MRD levels, while clonoSEQ continues to detect MRD at lower frequencies.

Figure 10: Measurements of the clonoSEQ Assay Compared to mpFC Measurements from ALL (left) and MM (right) Clinical Studies.

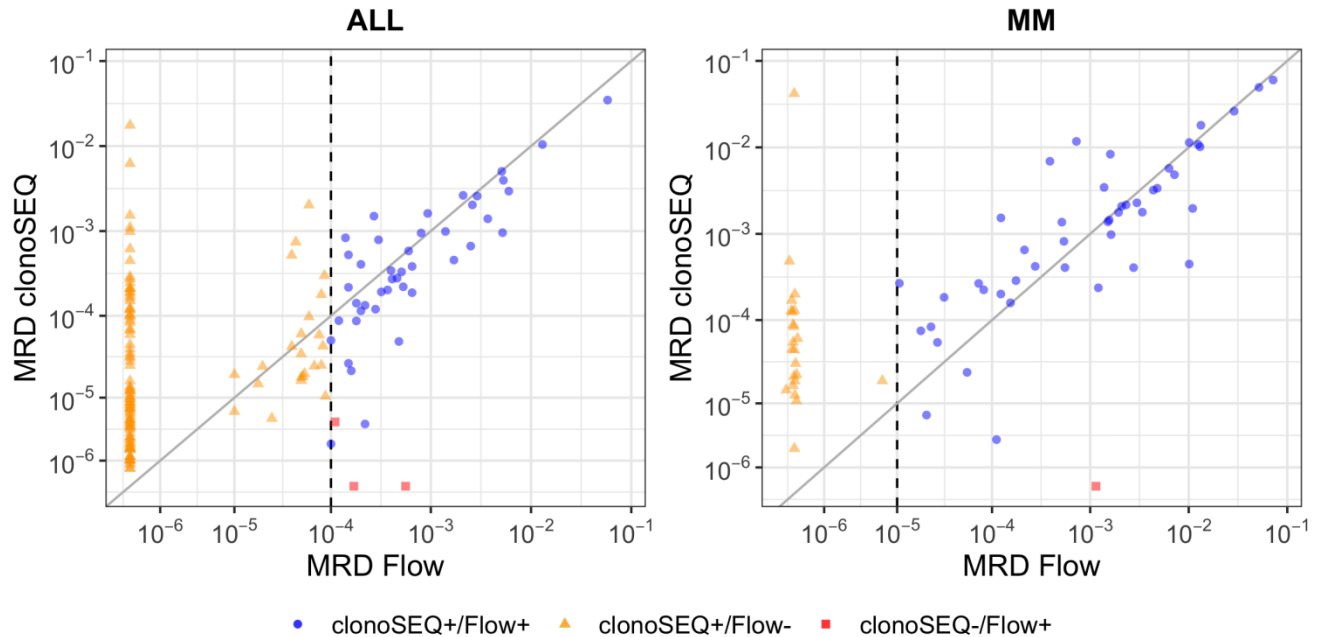

2.9.4 Concordance with mpFC in CLL Blood Clinical Samples

This study assessed concordance in two ways: concordance of MRD positive or negative calls and concordance of quantitative MRD frequency. This study compared MRD results reported by the clonoSEQ Assay to mpFC. The flow study included 299 matched samples. In a comparison of qualitative calls between mpFC and the clonoSEQ Assay, MRD negativity was defined as $< 10^{-4}$ for flow and $\text{MRD} < \text{LOD}$ for the clonoSEQ Assay. The positive percent agreement (PPA) between the clonoSEQ Assay and flow was 98.9%, with a 95% confidence bound of 94.3%-100%. The negative percent agreement (NPA) was 47.5%, with a 95% confidence bound of 40.5%-54.6% (**Table 15**). A PPA $> 98\%$ demonstrates the high concordance of positive calls between flow and the clonoSEQ Assay, while an NPA $< 50\%$ reflects the greater sensitivity of the clonoSEQ Assay, with 107 samples being called MRD positive by clonoSEQ and MRD negative by flow. These results demonstrate the high concordance between the MRD calls of these 2 technologies.

Table 15: Summary of mpFC vs. the clonoSEQ Assay Concordance Data for CLL

	flow MRD+	flow MRD-	PPA (95% CI)	NPA (95% CI)
clonoSEQ MRD+	94	107	98.9% (94.3-100%)	47.5% (40.5-54.6%)
clonoSEQ MRD-	1	97		

Concordance of MRD frequency between the clonoSEQ Assay (mpFC was shown by plotting MRD frequencies from the comparator against MRD frequencies from the clonoSEQ Assay (**Figure 11**). Concordance of MRD call is indicated by color; blue circles indicate samples with concordant MRD positive calls, while orange triangles and red squares denote discordant calls, with orange triangles indicating that clonoSEQ identified the sample as MRD positive and red squares indicating that the comparator identified the sample as MRD positive.

Figure 11: Measurements of the clonoSEQ Assay Compared to mpFC Measurements in CLL clinical samples.

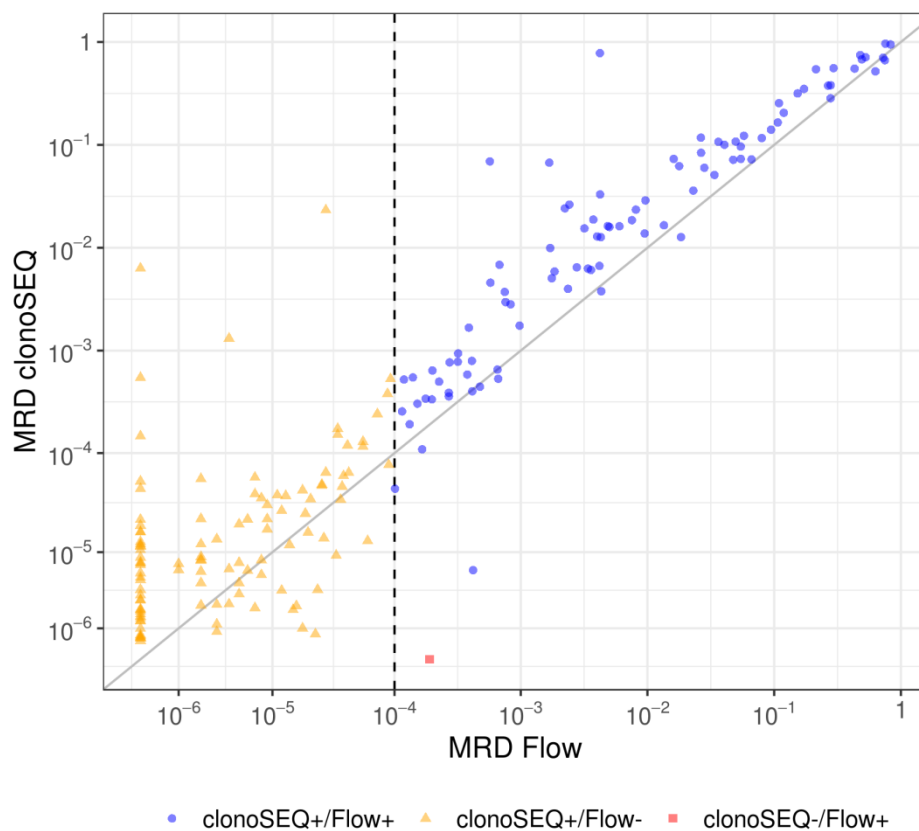

For mpFC, to quantify the similarity of reported MRD frequencies, correlations were calculated for samples with either concordant MRD calls or flow positive calls; MRD frequencies were highly concordant in this comparison (correlation coefficient = 97.2%, 95% CI = 96.4-97.9%).

These results demonstrate that flow and clonoSEQ report concordant MRD levels at high disease burdens, while clonoSEQ continues to detect MRD at lower frequencies.

2.9.5 Analysis of Quantitation Bias on Clinical Specimens

The BMA precision study evaluated blended samples of gDNA extracted from the BMA of healthy donors and gDNA from 23 MM, 21 ALL, and 22 CLL specimens at 3 DNA inputs and 6 MRD frequencies per DNA input. These data were reanalyzed to evaluate if there was a quantitation bias for clonoSEQ. Sample MRD frequencies measured with the assay were compared to the expected MRD value, as calculated using mpFC on the original clinical sample and applying the appropriate dilution factor.

Across all tested diseased cell inputs, the quantitation accuracy of the clonoSEQ Assay was within -25% to +25% in ALL, -10% to +60% in CLL, and -20% to +25% in MM (Figure 12). The assay tended to have a modest upward bias in MRD estimation at lower MRD frequencies and a modest downward bias at higher MRD frequencies (Figure 12). These biases were deemed to be minimal and acceptable.

The quantitation accuracy in CLL showed a similar trend across MRD frequencies, but there was an upward bias relative to ALL and MM, with the bias approaching 60% at lower MRD frequencies (Figure 12). An upward bias was also observed between the clonoSEQ Assay and mpFC in CLL clinical samples (Figure 12). These biases were deemed to be minimal and acceptable.

Figure 12: Bias Estimates of the clonoSEQ Assay by MRD Frequency using Clinical Specimens

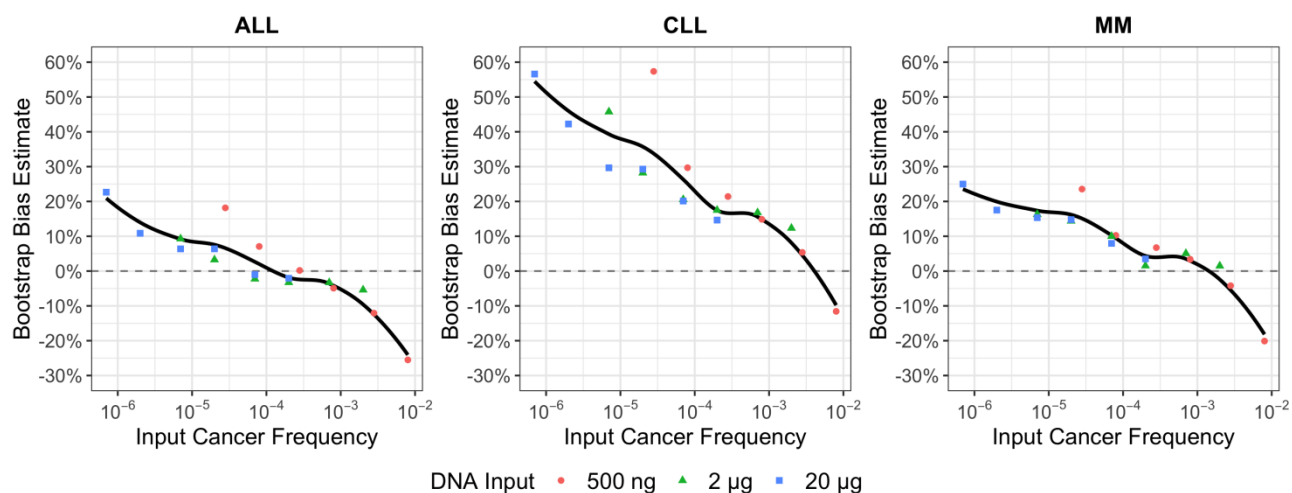

2.9.6 Repeatability of Nucleotide Base Calls

The repeatability of sequences generated by the clonoSEQ Assay was assessed using a two-step process. First, ID samples from 72 lymphoid malignancy samples and nine cell lines were processed to determine the baseline calibrating clonotype nucleotide sequences. Next, 20 replicates of the samples were run at disease inputs of ~2 to 600 malignant cells across 4 DNA

inputs (10 ng, 500 ng, 2 µg, 20 µg). The replicates were tested using 3 operators, 2 instrument sets, and 4 reagent lots. These data were used to assess the observed rate of agreement between the nucleotide sequences chosen for tracking and the nucleotide sequences observed in contrived samples from the same biological specimens.

For each calibrating clonotype sequence in an ID sample, all sequences in the corresponding MRD samples within N bp were included for assessment of overall percent agreement (OPA), where N is defined for each sequence as the number of allowable mutations determined during specimen characterization by our calibration algorithm. N is chosen to capture somatic variation among B cells from the same clonal lineage without incorrectly grouping sequences from different clonal lineages. Once this population was established, the OPA between the original calibrating clonotype sequence and the sequences identified in the MRD assessment was calculated.

Table 16 reports the number of nucleotides assessed, the OPA, the lower and upper 95% confidence limits, and the OPA restated in the same terms as a Phred quality score (i.e., $-10 \times \log_{10}$ disagreement rate). This test assessed approximately 442.5 million nucleotides for sequence agreement, with an overall disagreement rate of approximately 3.5 parts per 100,000 (corresponding to a Phred score of about 44.5; in typical NGS applications a Phred score of 30 or higher constitutes a high-quality base call).

Table 16: Summary of Sequence Agreement Metrics

Allowed Mutations	Nucleotides Assessed	OPA	LCL	UCL	Phred
1	135,025,044	99.9968	99.9967	99.9969	44.9
2	57,248,770	99.9965	99.9964	99.9967	44.6
3	151,018,837	99.9965	99.9965	99.9966	44.6
4	82,780,612	99.9960	99.9959	99.9962	44.0
5	13,918,166	99.9966	99.9963	99.9969	44.6
6	2,587,014	99.9961	99.9953	99.9968	44.1

The observed sequence error rates are extremely low. Sequence error does not represent a reasonable risk for generating false negative results even when a single copy of the relevant MRD sequence is observed.

2.10 Amplification Bias by Clonotype

Two types of studies were executed to assess amplification bias. One study used a comprehensive panel of synthetic double-stranded molecules representing rearrangements of the targeted exons, while the other used clinical samples. Data from amplification of the synthetic templates demonstrate that the clonoSEQ Assay amplifies the targeted exon segments efficiently and consistently with nominal bias. These conclusions were supported by data from clinical samples which show that patients who carry certain exons in their malignant clonotypes do not have biased precision profiles.

3 Clinical Studies

Clinical validation was demonstrated using an analysis of samples obtained from 2 previously conducted clinical studies in ALL, one ongoing study and one completed study in MM and one ongoing study and one completed study in CLL.

Samples for the analysis of the clonoSEQ Assay performance in ALL were obtained from two studies sponsored by the Children's Oncology Group (COG). COG study AALL0331 is a Phase III randomized study of different combination chemotherapy regimens in pediatric patients with newly diagnosed standard risk B-precursor acute lymphoblastic leukemia. COG study AALL0232 is a Phase III randomized study of dexamethasone versus prednisone during induction and high-dose methotrexate with leucovorin rescue versus escalating-dose methotrexate without leucovorin rescue during Interim Maintenance I in patients with newly diagnosed high-risk acute lymphoblastic leukemia.

Samples for the analysis of the clonoSEQ Assay performance in MM were obtained from an ongoing randomized, open label, Phase III Study of a lenalidomide and bortezomib in a combination therapy regimen (DFCI Study 10-106). Multiple timepoints were assessed in this two-arm analysis and not all patients have the same number of MRD assessments (see data in Section 3.2). Patients on Arm A (blinded to Adaptive Biotechnologies) had assessments after eight cycles of RVD, and then after lenalidomide maintenance. Patients on Arm B (blinded to Adaptive Biotechnologies) were assessed following 3 cycles of RVD, following auto transplant and again after 2 more cycles of RVD consolidation, and then following lenalidomide maintenance.

Samples and outcomes data for the analysis of the clonoSEQ Assay performance in CLL in blood were obtained from two trials. One sample set comes from an ongoing study titled, "A Prospective, Open-Label, Multicenter Randomized Phase III Trial to Compare The Efficacy and Safety of A Combined Regimen of Obinutuzumab and Venetoclax (GDC-0199/ABT-199) Versus Obinutuzumab and Chlorambucil in Previously Untreated Patients With CLL and Coexisting Medical Conditions" (NCT02242942). Multiple timepoints were assessed for MRD using the clonoSEQ Assay, though not all patients had the same number of evaluable MRD assessments. A second sample set comes from NCT00759798 which was a prospective, phase 2 clinical trial that evaluated six cycles of fludarabine, cyclophosphamide, and rituximab (FCR) in 62 front-line chronic lymphocytic leukemia (CLL) patients who were initially determined to be U-MRD (undetectable MRD, conceptually equivalent to MRD-negative) by 4-color flow cytometry at an MRD threshold of 10^{-4} .

3.1 Clinical Validation of the clonoSEQ Assay for Acute Lymphoblastic Leukemia in Children's Oncology Group (COG) Studies AALL0232 and AALL0331

The primary objective of the study was to establish the ability of the clonoSEQ Assay to predict event-free survival (EFS) at the MRD threshold of 10^{-4} using available bone marrow samples from patients who were enrolled in previously conducted COG studies AALL0232 and

AALL0331. The study was also designed to evaluate the clinical utility of the clonoSEQ Assay using alternative MRD thresholds and continuous MRD measures.

COG study AALL0331 is a Phase III randomized study of different combination chemotherapy regimens in pediatric patients with newly diagnosed standard risk B-precursor acute lymphoblastic leukemia.² COG study AALL0232 is a Phase III randomized study of dexamethasone versus prednisone during induction and high-dose methotrexate with leucovorin rescue versus escalating-dose methotrexate without leucovorin rescue during Interim Maintenance I in patients with newly diagnosed high-risk acute lymphoblastic leukemia.² Within these studies, bone marrow was collected at 6 separate time points to assess response to treatment; however, only the post induction marrow was used for MRD determination.

Clinical samples (pre-treatment BMA and day 29 post-induction BMA) were collected from 619 individuals, with samples from 315 patients who were enrolled as part of the “high risk” COG protocol AALL0232 and samples from 304 patients enrolled as part of the “standard risk” COG protocol AALL0331. Available specimens from these trials were tested with the clonoSEQ Assay and results from both studies were pooled into a single analysis. Specimens were selected based on having a sufficient quantity of gDNA, available MRD mpFC results and patients with study related endpoints for EFS and overall survival.

A subset of 283 of the 619 patients originally enrolled in COG studies AALL0232 and AALL0331 had leftover samples of sufficient amount that could be tested with the clonoSEQ Assay. The population characteristics between these 283 patients were compared against the remaining 336 that were not tested and there were no significant differences in any characteristic that was evaluated, including age, gender, presence of specific genetic fusions, trisomy, and progression free survival. The 283 bone marrow specimens were tested to evaluate the clinical performance of the clonoSEQ Assay and to demonstrate concordance in MRD measurements between the clonoSEQ Assay and results of original testing with a previous version of the clonoSEQ Assay and mpFC. Ten specimens did not pass QC, leaving results from 273 specimens available for the final analysis.

The clonoSEQ Assay MRD negativity at $\leq 10^{-4}$ was found to predict improved EFS irrespective of age ($P=0.0034$; **Figure 13**). Results demonstrate a 2.74-fold higher event risk in MRD positive patients ($\text{MRD} > 10^{-4}$) compared to MRD negative patients (95% CI: 1.330-5.656). Similar findings were published in a broader COG analysis of the relationship between EFS and MRD negativity by an earlier version of the clonoSEQ Assay in pediatric ALL.¹

Figure 13: Kaplan-Meier Survival Curve for EFS using the clonoSEQ Assay at an MRD Cutoff of 10^{-4} in ALL

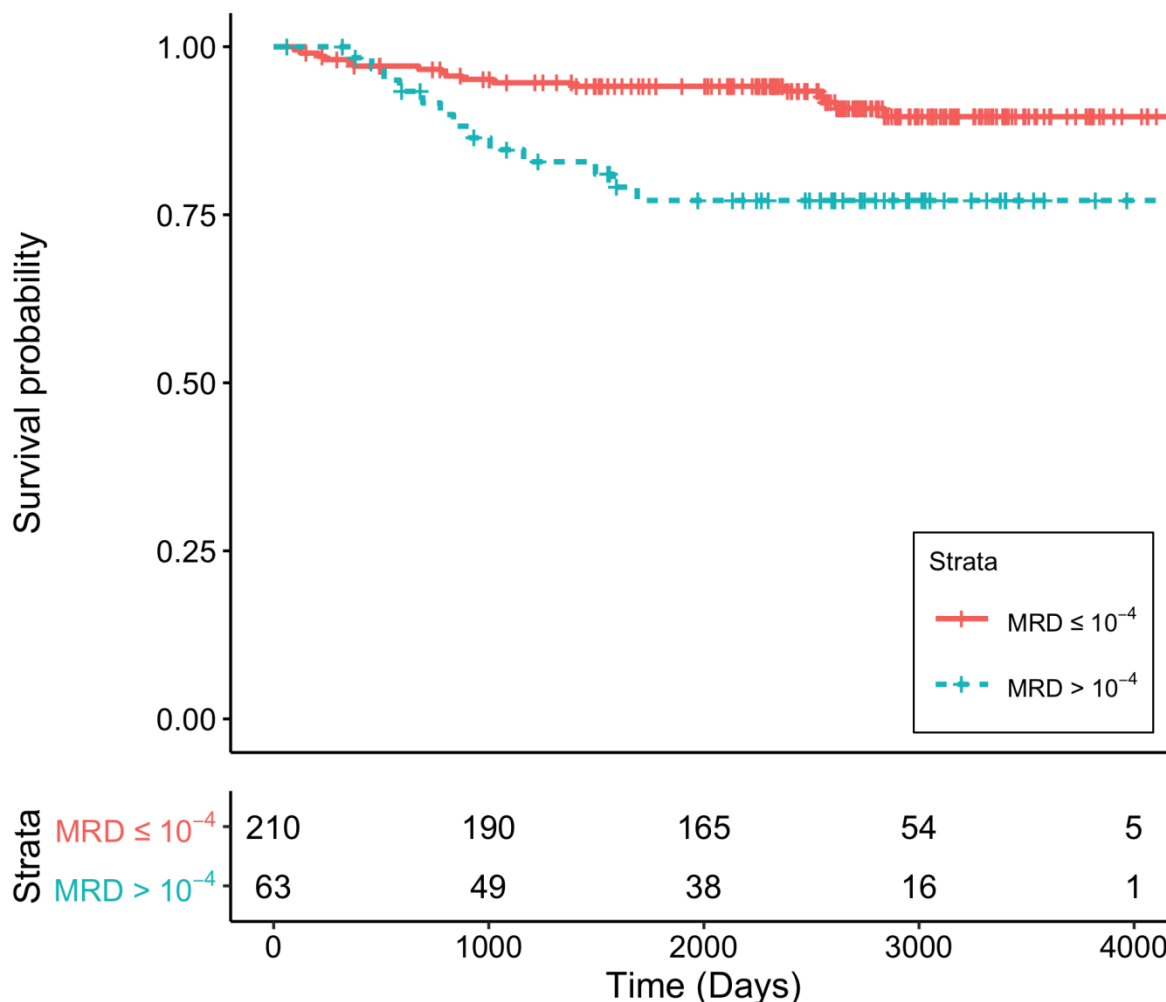

Cox regression analysis of MRD and EFS using continuous MRD values demonstrates that the clonoSEQ Assay is significantly associated with EFS after adjusting for age ($P=0.0057$) and that each 10-fold increase in MRD level is associated with a 1.499-fold increase in event risk (95% CI: 1.139-1.974). These data further demonstrate that the MRD level remains a significant predictor of EFS even after accounting for age, gender, and genetic abnormalities, which demonstrates the utility of MRD measurement in ALL.

Qualitative assessments of MRD were also evaluated with MRD negativity defined as $\leq 10^{-5}$ (Figure 14) is significantly associated with EFS ($P=8.4 \times 10^{-4}$).

Figure 14: Kaplan-Meier Survival Curve for EFS using the clonoSEQ Assay at an MRD Cutoff of 10^{-5} in ALL

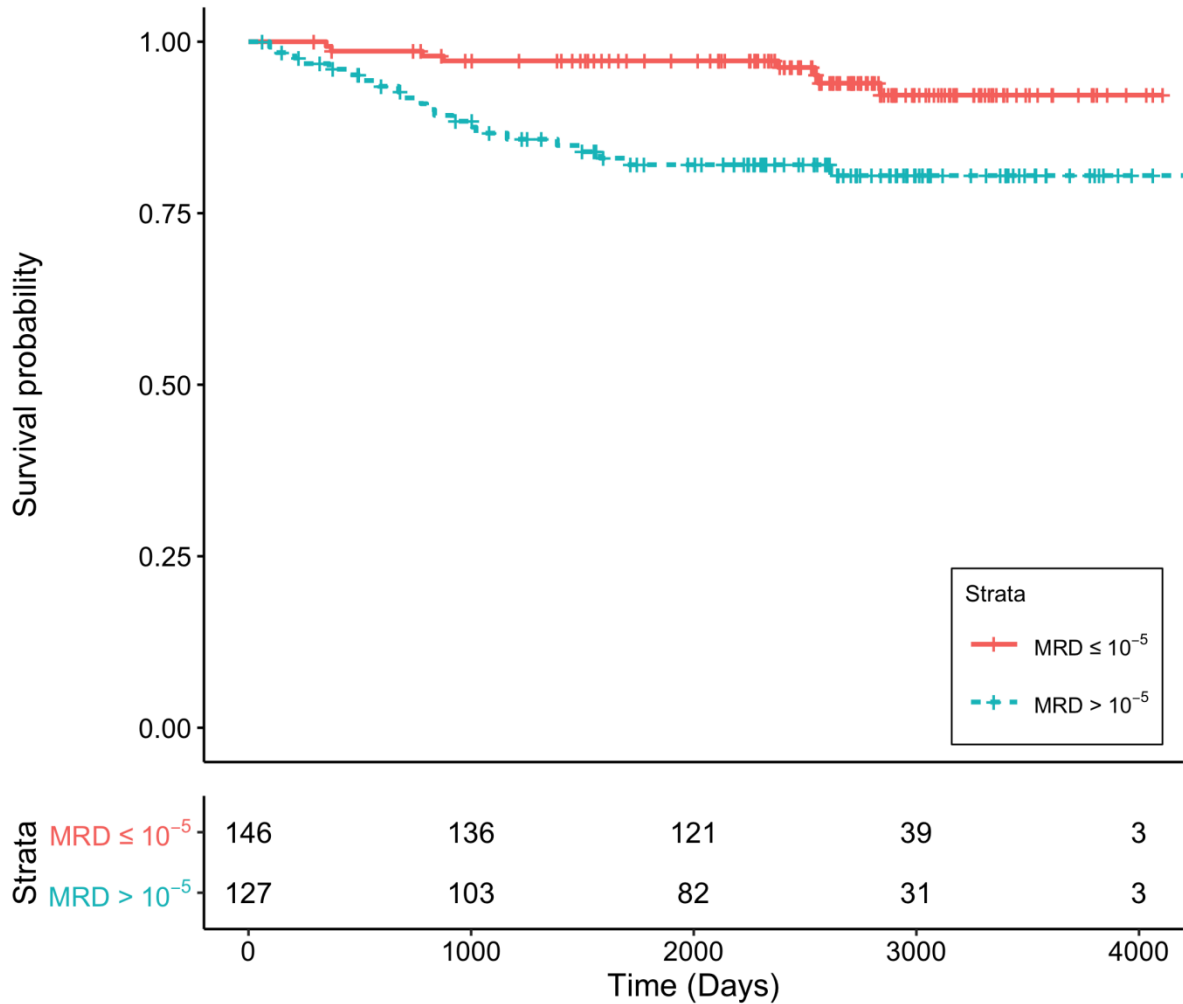

The clonoSEQ Assay was used to assess MRD at various disease burden thresholds to determine the correlation of MRD level with EFS. Patients who are clonoSEQ MRD negative ($\leq 10^{-5}$) have longer EFS, followed by patients with MRD between 10^{-5} and 10^{-4} and patients with $\text{MRD} \geq 10^{-4}$ ($p = 6.5 \times 10^{-4}$; **Figure 15**). These data demonstrate that patients with the lowest levels of MRD have better outcomes than patients with higher disease burden regardless of risk stratification.

Figure 15: Kaplan-Meier Survival Curve for EFS using the clonoSEQ Assay with 3 MRD Bins in ALL: $\leq 10^{-5}$, $10^{-5} - 10^{-4}$, $\geq 10^{-4}$.

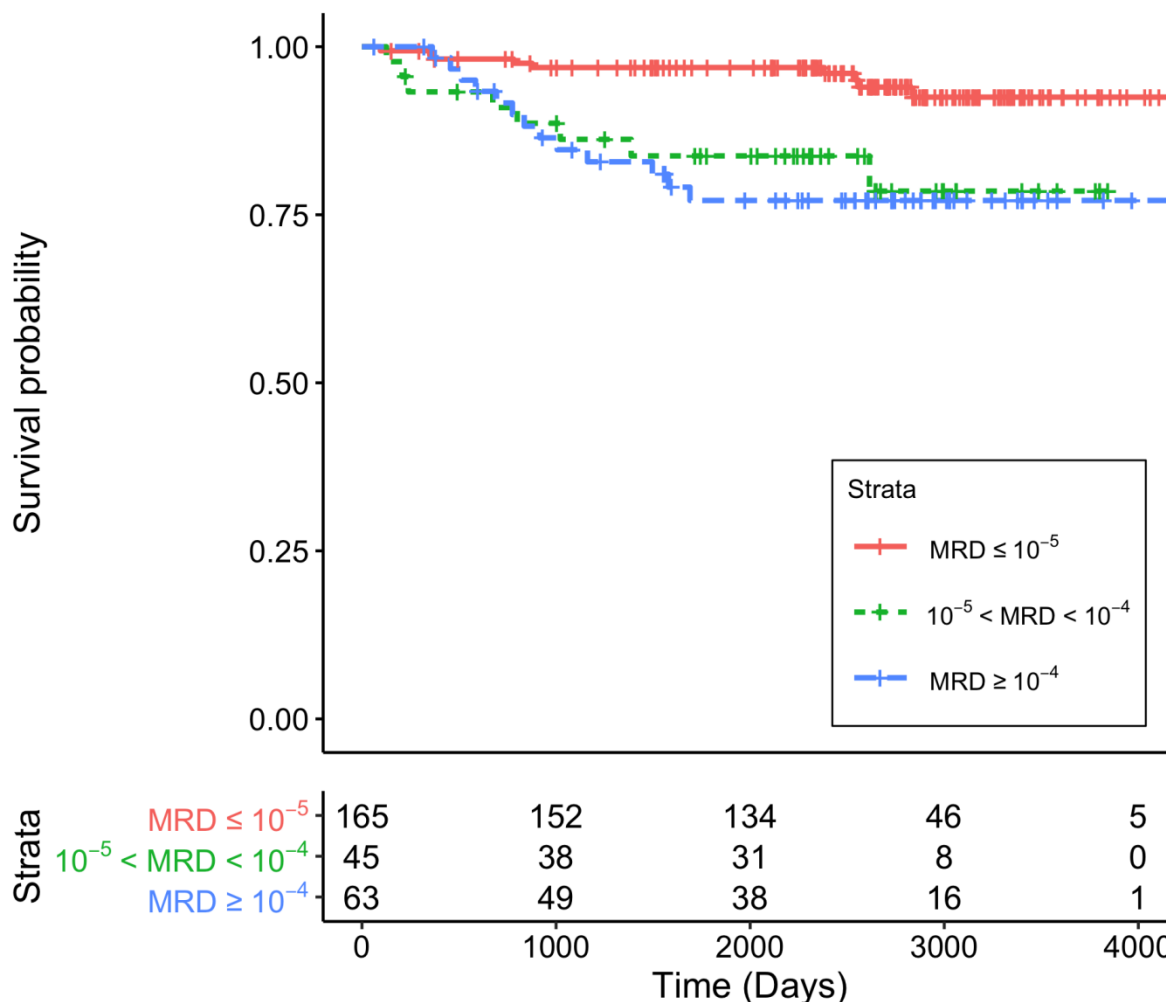

These analyses demonstrated that MRD estimation by the clonoSEQ Assay is associated with patient outcomes for B-cell precursor ALL.

3.2 Clinical Validation of the clonoSEQ Assay for Multiple Myeloma

Two separate studies were analyzed to support that MRD as estimated with the clonoSEQ Assay is associated with patient outcomes in MM, including the DFCI Study 10-106 and the ALCYONE study.^{3,4}

The objective of this study was to establish that the clonoSEQ Assay is predictive of progression-free survival (PFS) and disease-free survival (DFS) in MM. Patient samples were accrued under DFCI Study 10-106, “A Randomized Phase III Study Comparing Conventional Dose Treatment Using a Combination of Lenalidomide, Bortezomib, and Dexamethasone (RVD) to High-Dose Treatment with Peripheral Stem Cell Transplant in the Initial Management of Myeloma in Patients up to 65 Years of Age.”

A subset of 365 of the 720 patients originally enrolled in DFCI Study 10-106 had leftover samples of sufficient amount to be tested with the clonoSEQ Assay. The population characteristics between these 365 patients were compared against the remaining 355 patients that were not tested and there were no significant differences in any characteristic that was evaluated, including age, gender, ISS staging, cytogenetic status and progression free survival. Samples from 365 patients were tested and results from 323 patients were evaluable and passed QC. Seventy-five of the samples were available from patients in complete response (CR) at the time of first MRD assessment. This study aimed to demonstrate the association of the first MRD measurement with DFS in patients who achieved CR and with PFS in all evaluable patients. Samples from 75 patients who had achieved CR were evaluable for analysis. Continuous clonoSEQ MRD levels were modestly associated with DFS in patients who have achieved CR ($p = 0.064$) such that patient with lower MRD levels were less likely to progress.

The ability of the clonoSEQ Assay MRD measurements to predict PFS in all 323 evaluable patients was also assessed. clonoSEQ measurements demonstrated that MRD status at a threshold of 10^{-5} significantly predicts PFS in all patients ($p = 0.027$, **Figure 16**).

Figure 16: Kaplan-Meier Survival Curve for PFS using the clonoSEQ Assay at an MRD cutoff of 10^{-5} in MM

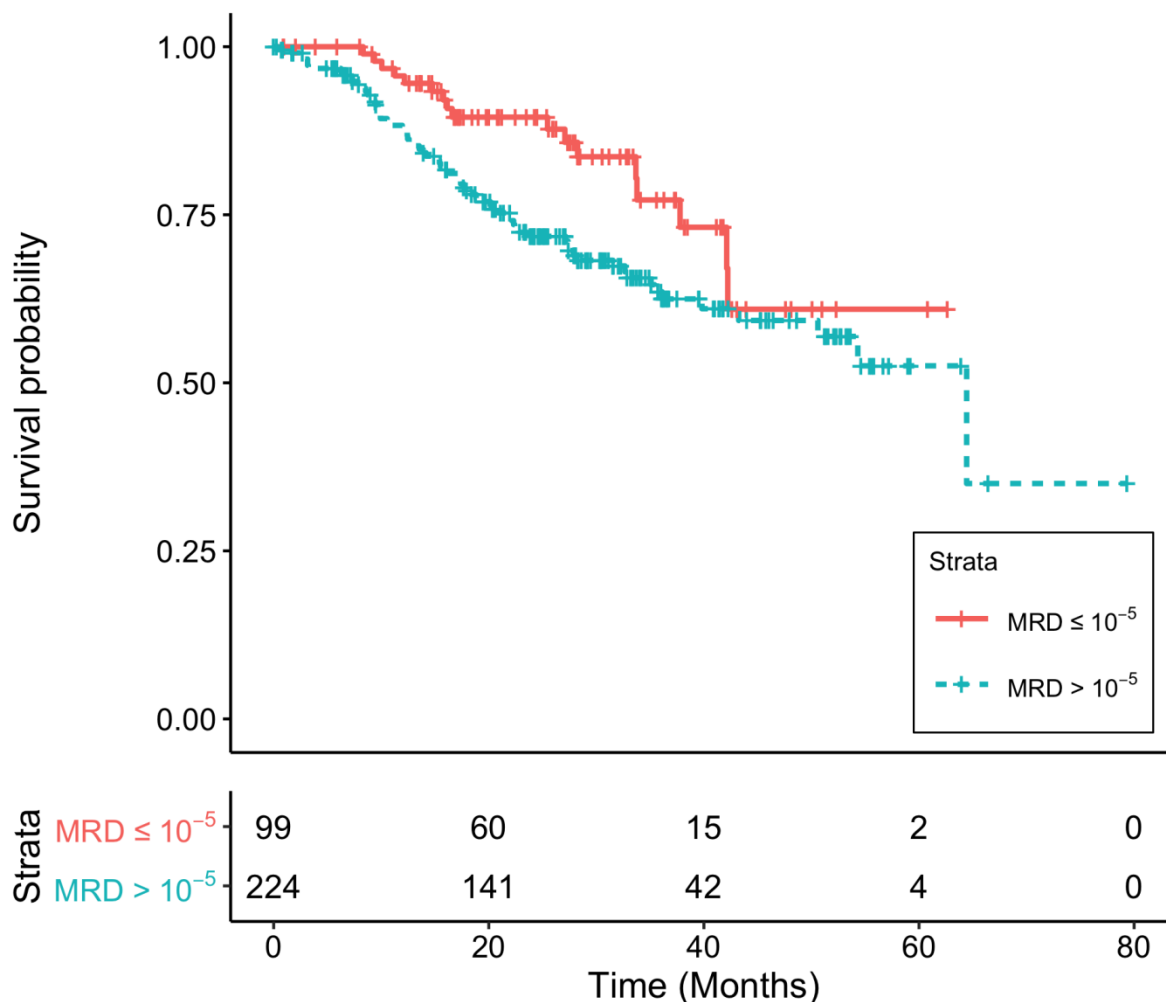

Cox regression analysis using a continuous measure of MRD was also associated with disease progression ($p = 1.9 \times 10^{-7}$). For every 10-fold increase in continuous clonoSEQ MRD measurement, the likelihood of an event is 1.69 times higher (95% CI: 1.071-2.67).

The ALCYONE Trial was a multicenter, randomized, open-label, active-controlled phase 3 trial that evaluated daratumumab plus bortezomib, melphalan and prednisone (D-VMP) versus bortezomib, melphalan and prednisone (VMP) in 706 patients with newly diagnosed multiple myeloma who were ineligible for stem-cell transplantation. The result of this study was reported in Mateos et al. 2018.⁴

Within this trial, MRD was assessed by the clonoSEQ Assay using of BMA collected at screening, at the time of confirmation of complete response or stringent complete response, and at 12, 18, 24, and 30 months after the first dose in patients having a complete response or stringent complete response. Patients who did not achieve a CR were considered to be MRD positive. An MRD threshold of 10^{-5} was used for analysis.

Regardless of treatment group, patients who were MRD negative by the clonoSEQ Assay at $\leq 10^{-5}$ had longer PFS compared to MRD positive patients (Figure 17). In patients with persistent MRD, PFS was longer in the daratumumab group than in the control group.

Figure 17: Analysis of MRD with Progression-Free Survival. Patients who were MRD negative by the clonoSEQ Assay had longer PFS compared to MRD positive patients.

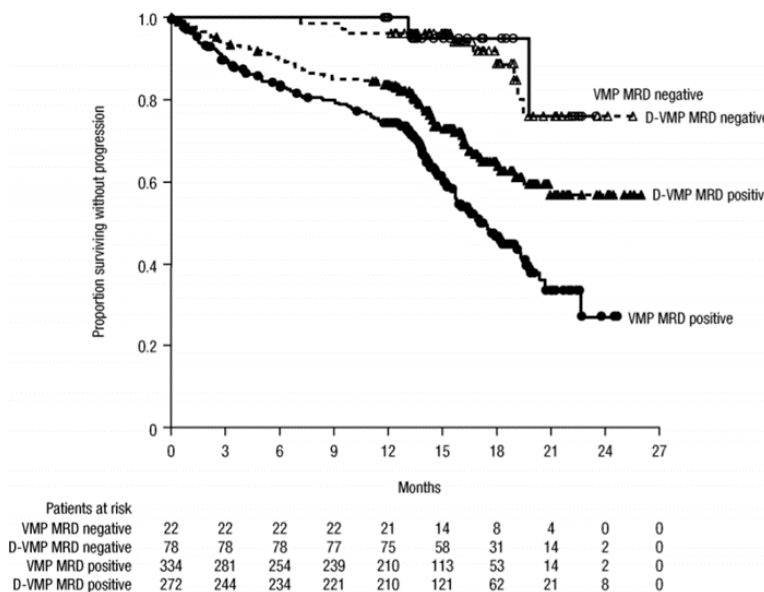

In summary, MRD negativity as measured by the clonoSEQ Assay was associated with improved patient outcomes in studies of ALL and MM. These data support the use of the clonoSEQ Assay to measure MRD and to be used for monitoring MRD in patients diagnosed with ALL and MM, to monitor changes in burden of disease during and after treatment.

3.3 Clinical Validation of the clonoSEQ Assay for Chronic Lymphocytic Leukemia

Two separate studies were analyzed to support that MRD as estimated with the clonoSEQ Assay is prognostic of patient outcomes in CLL, including data from clinical trials [NCT02242942](#) and [NCT00759798](#).^{5,6,13}

The primary objective of the first study was to evaluate the ability of the clonoSEQ Assay to predict progression-free survival (PFS) at the MRD threshold of 10^{-5} using available blood samples from patients accrued under clinical trial [NCT02242942](#), protocol BO25323, "A Prospective, Open-Label, Multicenter Randomized Phase III Trial to Compare The Efficacy and Safety of A Combined Regimen of Obinutuzumab and Venetoclax (GDC-0199/ABT-199) Versus Obinutuzumab and Chlorambucil in Previously Untreated Patients With CLL and Coexisting Medical Conditions."⁵ The study was also designed to evaluate the clinical utility of

the clonoSEQ Assay using continuous MRD measures and monitoring MRD across multiple time points.

Clinical trial NCT02242942 is a Phase III randomized trial to compare, in previously untreated patients, the efficiency and safety of a combined regimen of obinutuzumab and venetoclax (GDC-0199/ABT-199) versus obinutuzumab and chlorambucil. Samples and outcomes data were collected from 445 patients. For the clinical trial, blood was collected at multiple timepoints during and after treatment; for this study, only samples collected three months following treatment (FUM3) or later were included in analyses. While all available specimens from this trial were tested with the clonoSEQ Assay, 359 of the 445 patients originally enrolled in clinical trial NCT02242942 had both clinical outcomes data and sample material from the FUM3 timepoint available for analysis. Of these, one patient's sample failed QC, leaving 358 with usable clonoSEQ Assay MRD data. Twenty-one patients progressed prior to the FUM3 timepoint, leaving 337 patients for primary analysis.

The ability of MRD measurements from the clonoSEQ Assay at FUM3 to predict PFS was evaluated in these 337 patients. MRD negativity at $< 10^{-5}$ by the clonoSEQ Assay significantly predicted PFS ($p = 3.075 \times 10^{-19}$, **Figure 18**), with a 6.64-fold higher event risk in MRD positive patients ($\text{MRD} \geq 10^{-5}$) compared to MRD negative patients (95% CI: 3.65-12.1). Cox regression analysis of PFS using continuous MRD values demonstrated that the clonoSEQ Assay is significantly associated with PFS ($p = 2.96 \times 10^{-27}$) and that each 10-fold increase in MRD level is associated with a 2.15-fold increase in event risk (95% CI: 1.86-2.48). The results also show that the MRD level is a stronger predictor of PFS than other prognostic variables identified as clinically relevant covariates, or the treatment arm of the clinical trial. Together, these results demonstrate the clinical validity of MRD measurement in CLL.

Figure 18: Kaplan-Meier Survival Curves for PFS given clonoSEQ Assay MRD Calls at a Threshold of 10^{-5} at FUM3

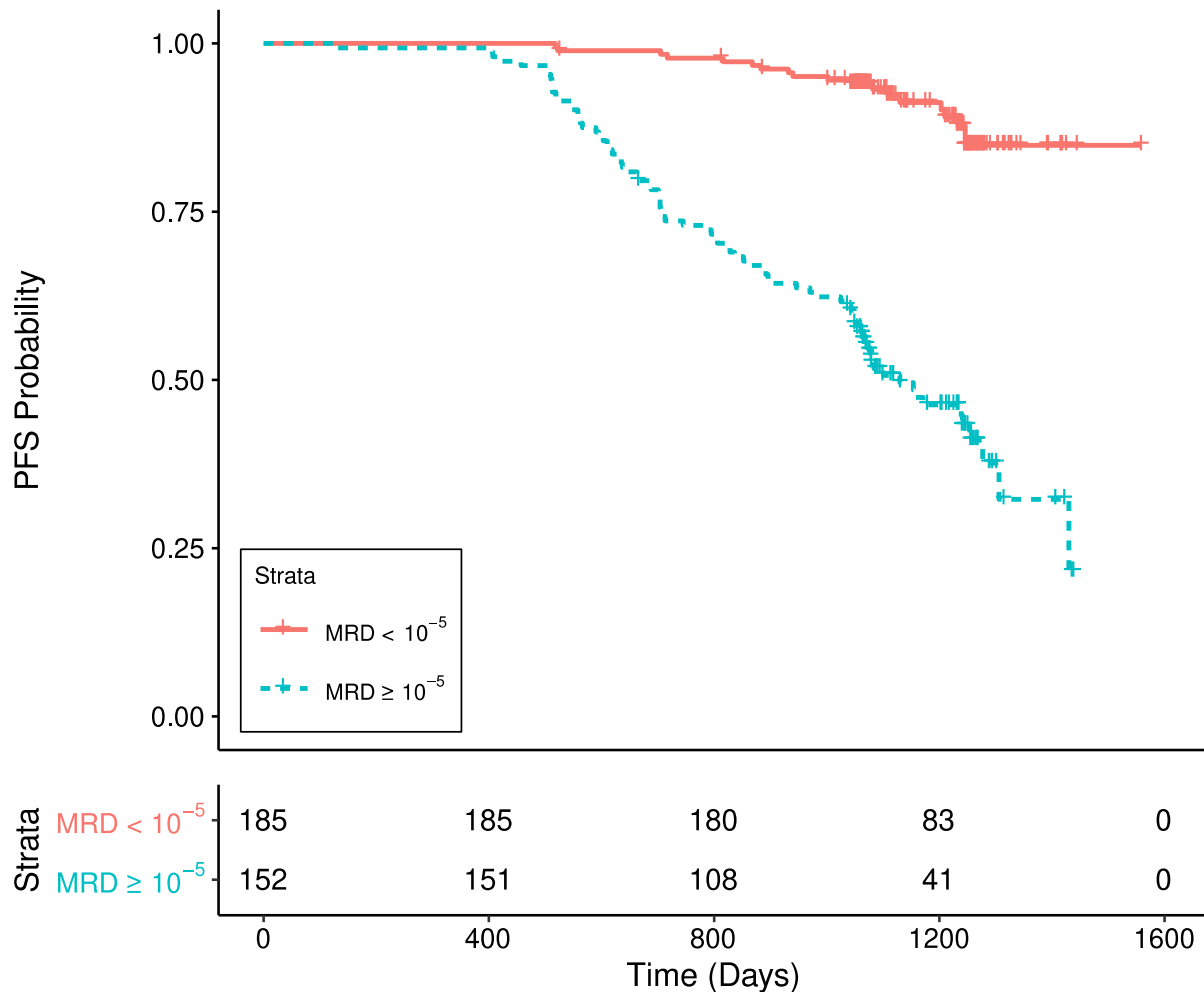

The clonoSEQ Assay was also used to assess MRD at various disease burden thresholds to determine the correlation of MRD level with PFS. Patients with clonoSEQ MRD < 10^{-6} or between 10^{-6} and 10^{-5} have longer PFS, followed by patients with MRD between 10^{-5} and 10^{-4} and patients with MRD $\geq 10^{-4}$ ($p = 4.902 \times 10^{-31}$, **Figure 19**). These data demonstrate that patients with MRD < 10^{-5} have better outcomes than patients with MRD $\geq 10^{-5}$, and that increasing MRD levels above 10^{-5} are associated with an increased risk of progression within the follow-up time of this study.

Figure 19: Kaplan-Meier Survival Curves for PFS using the clonoSEQ Assay with 4 MRD Bins in CLL at FUM3: $<10^{-6}$, $10^{-6} - 10^{-5}$, $10^{-5} - 10^{-4}$, $\geq 10^{-4}$

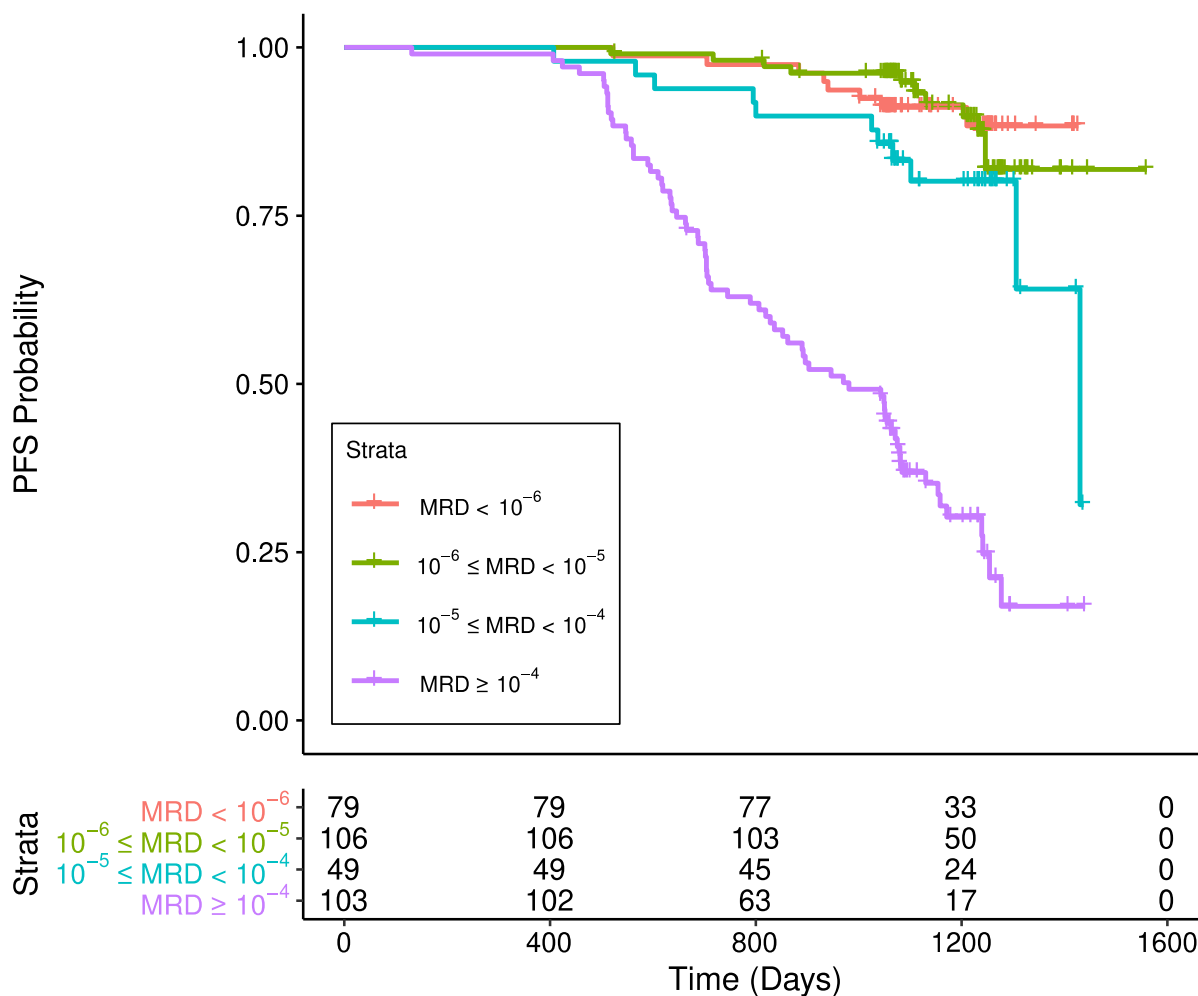

The second study, Thompson et al, was a prospective, phase 2 clinical trial that evaluated six cycles of fludarabine, cyclophosphamide, and rituximab (FCR) in 111 front-line chronic lymphocytic leukemia (CLL) patients with clonoSEQ ID samples and a corresponding 137 clonoSEQ MRD samples also evaluated by 4-color flow cytometry at an MRD threshold of 10^{-4} (NCT00759798) and with pertinent co-variate data.⁵ Within this cohort of 111 patients with flow MRD results, bone marrow was available for 75 patients and blood was available for 62 patients, of which 26 patients provided both blood and bone marrow. Due to some missing clinical covariates, 3 patients that provided bone marrow only were excluded from analyses requiring these covariates.

There is a significant association between PFS and continuous clonoSEQ MRD measurement in both blood and bone marrow, after end of treatment, where PFS is defined as the time from start of treatment until death, disease progression, or last time of disease assessment ($p = 9.66E-04$ for blood, $p = 2.13E-04$ for bone marrow). Additionally, patients who were MRD negative at a threshold $\leq 10^{-5}$ had superior progression-free survival compared to patients with MRD $> 10^{-5}$ ($p = .02$ for blood and $p = 8.17E-05$ for bone marrow, **Figure 20**). This association was also demonstrated at a threshold of 10^{-4} and 10^{-6} (**Figure 21** and **Figure 22**).

Figure 20: Kaplan-Meier Survival Curves for PFS given clonoSEQ Assay MRD Calls at a Threshold of 10^{-5} post-treatment (Left: Blood, Right: Bone Marrow)

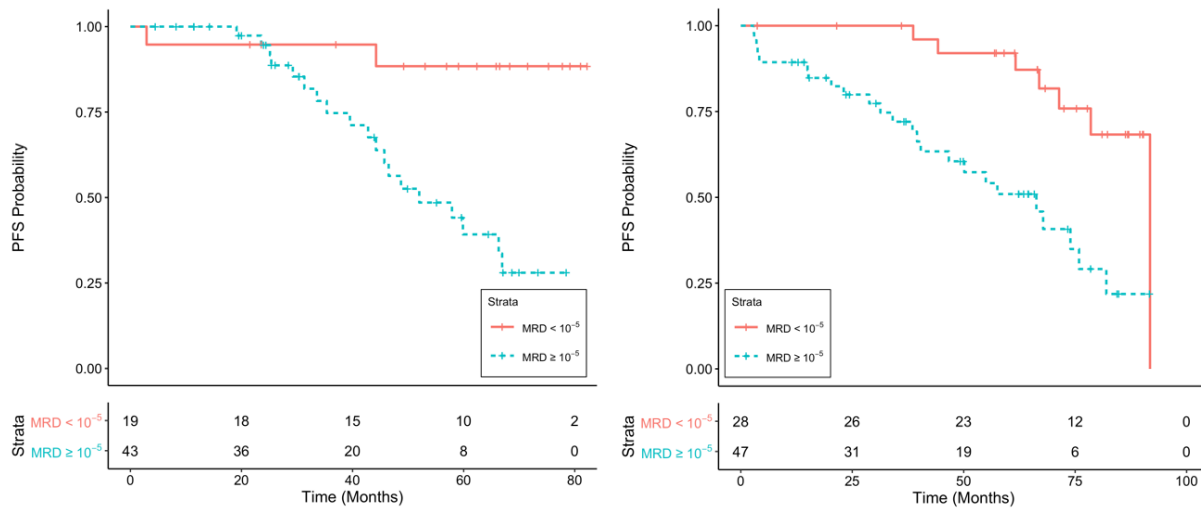

Figure 21: Kaplan-Meier Survival Curves for PFS given clonoSEQ Assay MRD Calls at a Threshold of 10^{-4} post-treatment (Left: Blood, Right: Bone Marrow)

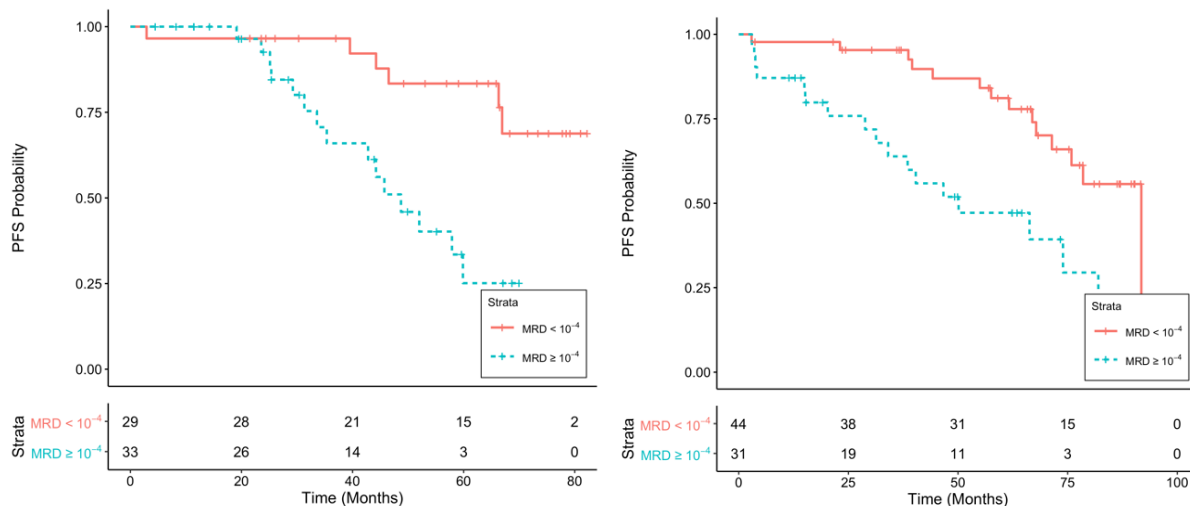
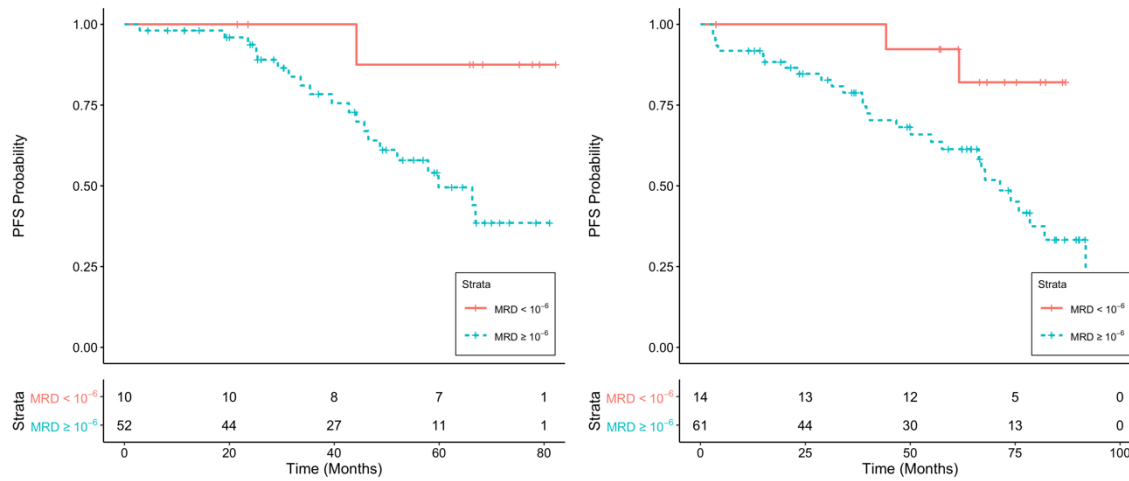

Figure 22: Kaplan-Meier Survival Curves for PFS given clonoSEQ Assay MRD Calls at a Threshold of 10^{-6} post-treatment (Left: Blood, Right: Bone Marrow)



Additional analysis of 26 patients compared disease burden between bone marrow and blood as assessed using clonoSEQ with MRD defined as detectable disease. Positive/negative calls are shown in **Figure 17**, and quantitative MRD values in **Figure 23**. Concordance was observed in 22/26 paired samples and discordance in 4/26. The median MRD level was 27% lower in blood than bone marrow which is consistent with previously published analysis.⁵

Table 17: Concordance of MRD call between blood and bone marrow

	Bone Marrow +	Bone Marrow -
Blood +	19	1
Blood -	3	3

Figure 23: Quantitative MRD assessment between blood and bone marrow.

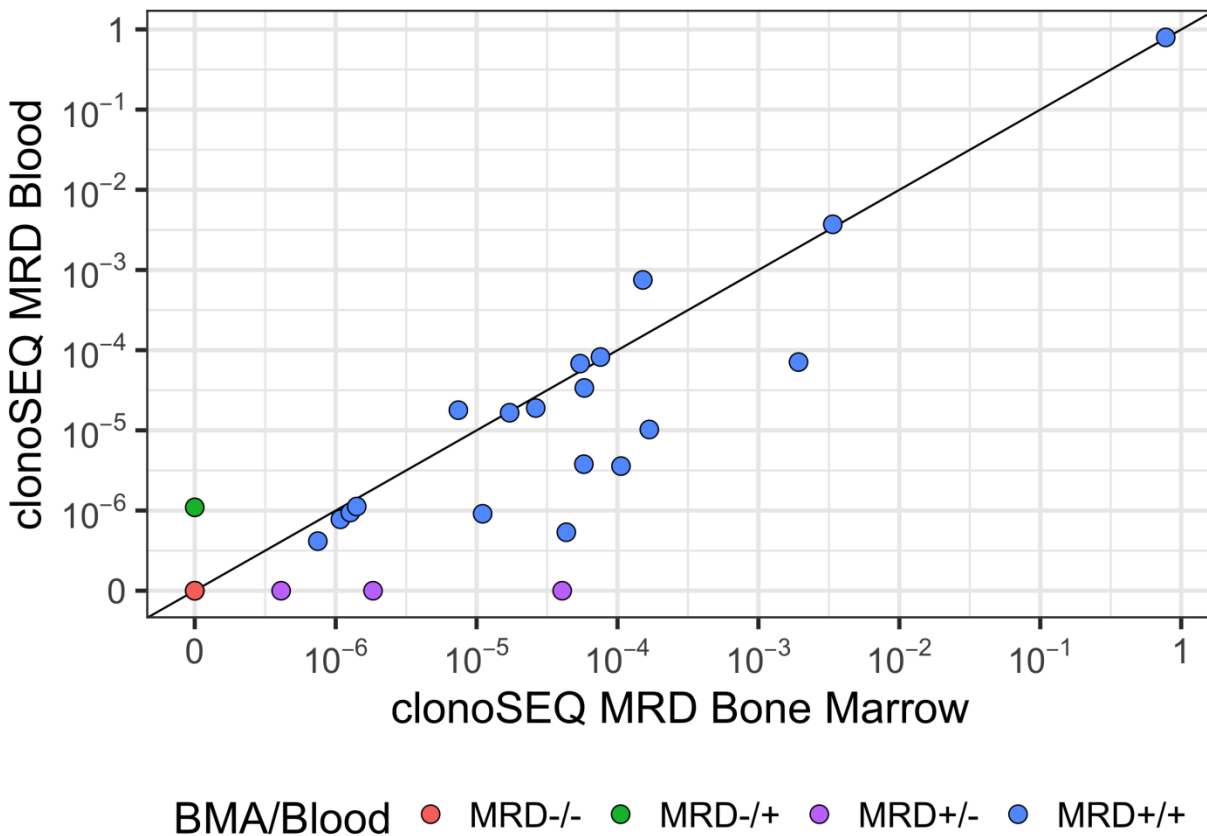

These studies demonstrate that MRD assessed using the clonoSEQ Assay in blood and bone marrow from CLL patients is prognostic of PFS and support the use of the clonoSEQ Assay to assess and monitor residual disease.

4 Summary

In summary, MRD negativity as measured by the clonoSEQ Assay was associated with improved patient outcomes in studies of ALL, MM and CLL. These data support the use of clonoSEQ to assess MRD and monitor residual disease in patients diagnosed with ALL, MM and CLL, in order to track changes in burden of disease during and after treatment. In samples from patients diagnosed with ALL, MM and CLL, the clonoSEQ Assay provides robust quantitative measurements of MRD frequencies from 10^{-6} - 10^{-4} , with sensitivity increasing in proportion to the amount of input material. Clinical outcomes are strongly associated with MRD levels measured by the assay for the purposes of detecting and monitoring residual disease in patients diagnosed with ALL, MM and CLL, in accordance with clinical guidelines.

5 References

1. Wood B, et.al., Measurable residual disease detection by high-throughput sequencing improves risk stratification for pediatric B-ALL. *Blood*. 2018 Mar 22;131(12):1350-1359
2. Borowitz M.J., et.al., Prognostic significance of minimal residual disease in high risk B-ALL: a report from Children's Oncology Group study AALL0232. *Blood*. 2015 Aug 20;126(8):964-71.
3. Randomized Trial of Lenalidomide, Bortezomib, Dexamethasone vs High-Dose Treatment with SCT in MM Patients up to Age 65 (DFCI Study 10-106), NCT01208662
4. Mateos M.V., et.al., for the ALCYONE Trial Investigators, Daratumumab plus Bortezomib, Melphalan, and Prednisone for Untreated Myeloma. *New England Journal of Medicine*. 2018 Feb 8;378(6):518-528
5. Thompson P. et al, Undetectable MRD Using Next Generation Sequencing is Associated With Improved PFS After Treatment with FCR for CLL. *Blood* 2019 28;134(22):1951-1959
6. Fischer K. et al, Venetoclax and Obinutuzumab in Patients with CLL and Coexisting Conditions. *New England Journal of Medicine*.2019; 380:2225-2236.
7. NCCN Clinical Practice Guidelines in Oncology: Acute Lymphoblastic Leukemia. Version 1. 2018.
8. NCCN Clinical Practice Guidelines in Oncology: Multiple Myeloma. Version 1.2018.
9. Hallek M., et al., iwCLL guidelines for diagnosis, indications for treatment, response assessment, and supportive management of CLL. *Blood*. 2018, 131(25):2745-2760
10. NCCN Clinical Practice Guidelines in Oncology: Chronic Lymphocytic Leukemia. Version 1.2020
11. Hallek M, et al. Guidelines for the diagnosis and treatment of chronic lymphocytic leukemia: a report from the International Workshop on Chronic Lymphocytic Leukemia updating the National Cancer Institute–Working Group 1996 guidelines. *Blood*. 2008;111(12):5446-5456
12. Rawstron AC, et al. International standardized approach for flow cytometric residual disease monitoring in chronic lymphocytic leukaemia. *Leukemia*. 2007;21(5):956-964.

6 Specimen and Shipping Instructions

Please refer to the clonoSEQ web site for detailed requirements:
www.adaptivebiotech.com/clonoseq/ordering

This page intentionally left blank